



ControlLogix 5570 Redundancy



Allen-Bradley

by ROCKWELL AUTOMATION

User Manual

Original Instructions

Important User Information

Read this document and the documents listed in the additional resources section about installation, configuration, and operation of this equipment before you install, configure, operate, or maintain this product. Users are required to familiarize themselves with installation and wiring instructions in addition to requirements of all applicable codes, laws, and standards.

Activities including installation, adjustments, putting into service, use, assembly, disassembly, and maintenance are required to be carried out by suitably trained personnel in accordance with applicable code of practice.

If this equipment is used in a manner not specified by the manufacturer, the protection provided by the equipment may be impaired.

In no event will Rockwell Automation, Inc. be responsible or liable for indirect or consequential damages resulting from the use or application of this equipment.

The examples and diagrams in this manual are included solely for illustrative purposes. Because of the many variables and requirements associated with any particular installation, Rockwell Automation, Inc. cannot assume responsibility or liability for actual use based on the examples and diagrams.

No patent liability is assumed by Rockwell Automation, Inc. with respect to use of information, circuits, equipment, or software described in this manual.

Reproduction of the contents of this manual, in whole or in part, without written permission of Rockwell Automation, Inc., is prohibited.

Throughout this manual, when necessary, we use notes to make you aware of safety considerations.



WARNING: Identifies information about practices or circumstances that can cause an explosion in a hazardous environment, which may lead to personal injury or death, property damage, or economic loss.



ATTENTION: Identifies information about practices or circumstances that can lead to personal injury or death, property damage, or economic loss. Attentions help you identify a hazard, avoid a hazard, and recognize the consequence.

IMPORTANT Identifies information that is critical for successful application and understanding of the product.

Labels may also be on or inside the equipment to provide specific precautions.



SHOCK HAZARD: Labels may be on or inside the equipment, for example, a drive or motor, to alert people that dangerous voltage may be present.



BURN HAZARD: Labels may be on or inside the equipment, for example, a drive or motor, to alert people that surfaces may reach dangerous temperatures.



ARC FLASH HAZARD: Labels may be on or inside the equipment, for example, a motor control center, to alert people to potential Arc Flash. Arc Flash will cause severe injury or death. Wear proper Personal Protective Equipment (PPE). Follow ALL Regulatory requirements for safe work practices and for Personal Protective Equipment (PPE).

Preface

Summary of Changes	9
Overview	9
Additional Resources	10

Chapter 1

About ControlLogix Redundancy Systems

Features of the ControlLogix Redundancy System	11
Controller Keyswitch	13
Redundancy System Components	13
I/O Modules in Redundancy Systems	14
Redundancy System Operations	14
System Qualification and Synchronization	14
Switchovers	15
Restrictions	17

Chapter 2

Design a ControlLogix Redundancy System

Redundant Chassis	19
Redundant Chassis Configuration Requirements	19
Controllers in Redundant Chassis	20
Redundancy Modules in Redundant Chassis	21
Communication Modules in Redundant Chassis	22
Power Supplies and Redundant Power Supplies in Redundancy Systems	23
EtherNet/IP Networks with Redundant Systems	24
Unicast Functionality	24
Possible Communication Delays on EtherNet/IP and ControlNet Networks	24
Bridge from an EtherNet/IP Network to a ControlNet Network	24
ControlNet Networks with Redundant Systems	25
ControlNet Network Requirements	25
Redundant ControlNet Media	28
Other Communication Networks	29
I/O Placement	30
1715 Redundant I/O Systems	30
Using HMI	32
HMI Connected Via an EtherNet/IP Network	32
HMI Connected Via a ControlNet Network	33
Optional Software	34

Chapter 3	
Install the Redundancy System	
Before You Begin	35
Redundancy System Quick Start.....	35
Install the Hardware	37
Install the First Chassis	37
Install the Redundancy Module	37
Environment and Enclosure	38
Prevent Electrostatic Discharge	38
Removal and Insertion Under Power (RIUP)	38
European Hazardous Location Approval	39
Safety-related Programmable Electronic Systems.....	39
Optical Ports	39
Small Form-factor Pluggable.....	39
North American Hazardous Location Approval	40
Laser Radiation Ports	41
Install the Second Chassis	43
Connect the Redundancy Modules.....	43
Connect the Fiber-optic Communication Cable to Redundant Channels.....	44
Connect the Fiber-optic Communication Cable to Single Channels.....	45
Fiber-optic Cable	46
Use Dual Fiber Ports with the 1756-RM2 Redundancy Module	47
Update Redundant Firmware	48
Upgrade the Firmware in the First Chassis	48
Upgrade the Firmware in the Second Chassis	50
Designate the Primary and Secondary Chassis	50
After Designation.....	51
Conversion from a Non-redundant to a Redundant System.....	52
Qualification Status Via the RMCT	52
Reset the Redundancy Module	53
Remove or Replace the Redundancy Module	53
Chapter 4	
Configure the EtherNet/IP Network	
Requested Packet Interval	55
CPU Usage.....	55
IP Address Swapping.....	56
Static Versus Dynamic IP Addresses.....	58
Reset the IP Address for an EtherNet/IP Communication Module	58
CIP Sync	58
Produce/Consume Connections	61
Configure EtherNet/IP Communication Modules in a Redundant System.....	63
Before You Begin	63
Options for Setting the IP Addresses of EtherNet/IP Communication Modules	63
Half/Full Duplex Settings.....	63
Use a Redundancy System with Device Level Ring.....	64
Use a Redundancy System with Parallel Redundancy Protocol.....	64

Configure the ControlNet Network

Chapter 5

Produce/Consume Connections	65
Network Update Time	66
NUTs with Multiple ControlNet Networks	66
Scheduled or Unscheduled Network	68
Use a Scheduled Network	68
Use an Unscheduled Network.....	68
Add Remote ControlNet Modules While Online	68
Schedule a New Network	69
Update an Existing Scheduled Network	71
Check the Network Keeper States.....	73
Save the Project for Each Primary Controller	74
Automatic Keeper Crossloads.....	74

Configure the Redundancy Modules

Chapter 6

About the Redundancy Module Configuration Tool (RMCT).....	75
Determine If Further Configuration Is Required.....	76
Use the RMCT	76
Identify the RMCT Version	77
Update the RMCT Version.....	79
Module Info Tab	81
Configuration Tab	82
Auto-synchronization.....	83
Chassis ID	83
Enable User Program Control.....	83
Redundancy Module Date and Time.....	84
Synchronization Tab	85
Commands in the Synchronization Tab.....	86
Recent Synchronization Attempts Log.....	87
Synchronization Status Tab.....	88
System Update Tab.....	89
System Update Commands.....	89
System Update Lock Attempts	91
Locked Switchover Attempts.....	92

Program the Redundant Controller

Chapter 7

Configure the Redundant Controller.....	93
Enable Time Synchronization	95
Crossloads, Synchronization, and Switchovers.....	96
Changing Crossload and Synchronization Settings	96
Default Crossload and Synchronization Settings	97
Recommended Task Types	97
Continuous Task After Switchover	97
Multiple Periodic Tasks	98
Crossloads and Scan Time	100
Estimate the Crossload Time	100
Redundancy Object Attributes for Crossload Times	101
Equation for Estimating Crossload Times.....	102

- Program to Minimize Scan Times 103
 - Use a ControlLogix 5570 Controller with a 1756-RM2 Redundancy Module 103
 - Use Multiple Controllers 103
 - Minimize the Number of Programs 103
 - Manage Tags for Efficient Crossloads 104
 - Use Concise Programming 106
- Program to Maintain Data Integrity 108
 - Array (File)/Shift Instructions 108
 - Scan-dependent Logic 109
- Optimize Task Execution 111
 - Periodic Task Configuration Optimization 112
 - Continuous Task Configuration Optimization 113
 - Change the System Overhead Time Slice 114
- Conduct a Test Switchover 115
 - Synchronization After a Switchover 116
- Program Logic to Run After a Switchover 117
- Use Messages for Redundancy Commands 118
 - Verify User Program Control 118
 - Use an Unconnected Message 118
 - Configure the MSG Instruction 118
- Set the Task Watchdog 121
 - Minimum Value for the Watchdog Time 122
- Download the Project 123
- Store a Redundancy Project to Nonvolatile Memory 123
 - Store a Project While the Controller is in Program or Remote Program Mode 124
 - Store a Project While a System is Running 125
 - Load a Project 125
- Online Edits 126
 - Support for Partial Import Online 126
 - Plan for Test Edits 127
 - Assemble Edits with Caution 128
 - Reserve Memory for Tags and Logic 131

Chapter 8

Monitor and Maintain a Redundancy System

- Controller Logging 133
 - Controller Log 133
 - Controller Logging in Redundancy Systems 134
 - Component Change Detection 134
- Monitor System Status 134
- Verify Date and Time Settings 135
- Verify System Qualification 136
 - Check Qualification Status Via Module Status Displays 136
 - Check Qualification Status Via the RMCT 138
- Check the EtherNet/IP Module Status 139
 - CPU Usage 139
 - Connections Used 139

	Check the ControlNet Module Status	140
	ControlNet Module CPU Usage	141
	ControlNet Module Connections Used.....	141
	Monitor the ControlNet Network	141
	View the 1756-RM2 Fiber Channel Status From a Logix Designer Application	142
	Chapter 9	
Troubleshoot a Redundant System	General Troubleshooting Tasks.....	143
	Check the Module Status Indicators	143
	Use Programming Software to View Errors.....	145
	Redundant Controller Major Fault Codes	147
	Use the RMCT for Synchronization Attempts and Status.....	148
	Recent Synchronization Attempts.....	148
	Module-level Synchronization Status	149
	Use the RMCT Event Log	150
	Interpret Event Log Information.....	150
	Export All Event Logs	154
	Export Diagnostics	156
	Contact Rockwell Automation Technical Support.....	157
	Controller Events	158
	Event Log Tab	158
	Event Classifications.....	159
	Access Extended Information about an Event	161
	Interpret Extended Information for an Event	162
	Export Event Log Data	162
	Clear a Fault	166
	System Event History	167
	System Event History Column Descriptions.....	167
	Edit a User Comment for a System Event	168
	Save System Event History	168
	Event Examples	169
	Keeper Status Causing Synchronize Failure	170
	Check the Module Status Display.....	170
	Check Keeper Status in RSNetWorx for ControlNet Software ...	171
	Valid Keeper Status and Signatures	171
	Partner Network Connection Lost	173
	Redundancy Module Connection Lost.....	175
	Redundancy Module Missing	175
	Qualification Aborted Due to a Non-redundant Controller	176
Redundancy Module Status Indicators	178	
1756-RM2 and 1756-RM2XT Status Indicators.....	178	
1756-RM/A and 1756-RM/B Status Indicators	181	
Redundancy Module Fault Codes and Display Messages.....	183	
Recovery Messages	184	

Convert from a Non-redundant System	Appendix A	
	Update the Configuration in Programming Software.....	186
	Replace Local I/O Tags.....	187
	Replace Aliases to Local I/O Tags	188
	Remove Other Modules from the Controller Chassis.....	189
	Add an Identical Chassis.....	189
	Upgrade to Redundancy Firmware	189
Update the Controller Revision and Download the Project	190	
Redundancy Object Attributes	Appendix B	
	Table of Redundancy Object Attributes.....	191
Redundancy System Checklists	Appendix C	
	Chassis Configuration Checklist	195
	Remote I/O Checklist	195
	Redundancy Module Checklist.....	196
	ControlLogix Controller Checklist.....	196
	ControlNet Checklist.....	196
	EtherNet/IP Module Checklist	197
Project and Programming Checklist.....	198	
Index	199	

Summary of Changes

This table contains the changes that are made to this revision. Changes are identified by change bars.

Topic	Page
Added new section: Controller Keyswitch	13
Updated Fiber-optic Cable table	46
Updated the section, About the Redundancy Module Configuration Tool (RMCT)	75, 76, 79
Updated Enable Time Synchronization	95
Updated Conduct a Test Switchover	115
Updated Table 14 - MSG Instruction to Initiate a Switchover	119
Updated Table 16 - Disqualify the Secondary Chassis	120
Updated Table 17 - Synchronize the Secondary Chassis	120
Updated Table 18 - Set WallClockTime	121
Updated Check the EtherNet/IP Module Status	139
Added new section: View the 1756-RM2 Fiber Channel Status From a Logix Designer Application	142
Updated Convert from a Non-redundant System	185
Updated Table 49 - Components Available for Use in a Redundant Chassis Pair	189
Updated the Project and Programming Checklist	198

Overview

In this publication:

- ‘ControlLogix Redundancy’ refers to ControlLogix® 5570/5560 Redundancy.
- RSLinx® Classic and FactoryTalk® Linx are acceptable to use as communication software, and throughout this publication are referred to as ‘communication software’. For compatible communication software, see the release notes on the Product Compatibility and Download Center (PCDC).

This publication provides this information specific to redundancy systems:

- Design and planning considerations
- Installation procedures
- Configuration procedures
- Maintenance and troubleshooting methods

This publication is designed for use by anyone responsible for planning and implementing a ControlLogix redundancy system:

- Application engineers
- Control engineers
- Instrumentation technicians

The contents of this publication are for anyone who already has an understanding of Logix 5000® control systems, programming techniques, and communication networks.

Additional Resources

These documents contain additional information concerning related products from Rockwell Automation.

Table 1 - Additional Documentation

Resource	Description
1715 Redundant I/O System Specifications Technical Data, publication 1715-TD001	Contains specifications on a Redundant I/O system.
1756 ControlLogix Controllers Technical Data, publication 1756-TD001	Contains specifications on ControlLogix controllers and redundancy modules.
ControlLogix 5580 Redundant Controller User Manual, publication 1756-UM015	Describes how to install, configure, program, operate, and troubleshoot a ControlLogix® 5580 redundancy system..
High Availability Systems Reference Manual, publication HIGHAV-RM002	Provides information to help design and plan high availability systems.
ControlFLASH Firmware Upgrade Software User Manual, publication 1756-UM105	Describes how to use the ControlFLASH™ software to upgrade device firmware.
ControlFLASH Plus Quick Start Guide, publication CFP-QS001C-EN-E	Describes how to use the ControlFLASH Plus™ software to upgrade device firmware.
ControlLogix Redundancy Update and Module Replacement Guidelines Reference Manual, publication 1756-RM010	Provides instructions for replacing modules or updating firmware in a powered-up redundancy system.
ControlLogix System Selection Guide, publication 1756-SG001	Provides information on how to select components for a ControlLogix system.
ControlLogix System User Manual, publication 1756-UM001	Contains information on how to install, configure, program, and operate a ControlLogix system.
ControlNet Network Configuration User Manual, publication CNET-UM001	Describes ControlNet® modules and how to use ControlNet modules with a Logix 5000 controller.
EtherNet/IP Parallel Redundancy Protocol Application Technique, publication ENET-AT006	Describes how to configure a Parallel Redundancy Protocol (PRP) network with the 1756-EN2TP EtherNet/IP™ communication module and a Stratix® 5400 or 5410 switch.
EtherNet/IP Device Level Ring Application Technique, publication ENET-AT007	Describes how to install, configure, and maintain linear and Device Level Ring (DLR) networks that use Rockwell Automation® EtherNet/IP devices with embedded switch technology.
EtherNet/IP Socket Interface Application Technique, publication ENET-AT002	Logix 5000Describes the socket interface that you can use to program MSG instructions to communicate between a Logix 5000 controller via an EtherNet/IP module and Ethernet devices that do not support the EtherNet/IP application protocol.
EtherNet/IP Network Devices User Manual, publication ENET-UM006	Describes how to use EtherNet/IP communication modules with your Logix 5000 controller and communicate with various devices on the Ethernet network.
Integrated Architecture and CIP Sync Configuration Application Technique, publication IA-AT003	Provides an explanation of CIP Sync™ technology and how you can synchronize clocks within the Rockwell Automation Integrated Architecture®.
Logix 5000 Controllers Common Procedures Programming Manual, publication 1756-PM001	Provides links to a collection of programming manuals that describe how to use procedures that are common to all Logix 5000 controllers projects.
Logix 5000 Controllers General Instructions Reference Manual, publication 1756-RM003	This manual provides details about each available instruction for a Logix-based controller.
Logix 5000 Controllers Information and Status Programming Manual, publication 1756-PM015	Describes how Logix 5000 controllers use connections with other devices.
Logix 5000 Controllers I/O and Tag Data Programming Manual, publication 1756-PM004	Provides information on how to access I/O and tag data in Logix 5000 controllers.
Logix 5000 Controllers Major, Minor, and I/O Faults Programming Manual, publication 1756-PM014	Describes how to monitor and handle major and minor controller faults.
Logix 5000 Controllers Nonvolatile Memory Card Programming Manual, publication 1756-PM017	Provides information on how to access and use a memory card in Logix 5000 controllers.
Logix 5000 Produced and Consumed Tags Programming Manual, publication 1756-PM011	Provides information to produce and consume system-shared tags and produce a large array with a Logix 5000 controller.
Logix 5000 Controllers Quick Start, publication 1756-QS001	Provides information to program and maintain Logix 5000 controllers.
Logix 5000 Controllers Tasks, Programs, and Routines Programming Manual, publication 1756-PM005	Provides information to configure controller tasks and the programs and routines for the proper execution of these tasks.
PlantPAX DCS Configuration and Implementation User Manual, publication PROCES-UM100	Elaborates on the application rules that are required to configure a PlantPAX® system.
Using ControlLogix in SIL 2 Applications Safety Reference Manual, publication 1756-RM001	Provides safety-related information specific to the use of ControlLogix modules in SIL 2 systems.
Redundant I/O System User Manual, publication 1715-UM001	Contains information on how to install, configure, program, operate, and troubleshoot a Redundant I/O system.
Industrial Automation Wiring and Grounding Guidelines, publication 1770-4.1	Provides general guidelines for installing a Rockwell Automation industrial system.
Product Certifications website, rok.auto/certifications	Provides declarations of conformity, certificates, and other certification details.

You can view or download publications at [rok.auto/literature](#).

About ControlLogix Redundancy Systems

Topic	Page
Features of the ControlLogix Redundancy System	11
Controller Keyswitch	13
Redundancy System Components	13
Redundancy System Operations	14
Restrictions	17

IMPORTANT In this publication, 'ControlLogix Redundancy' refers to ControlLogix 5570/5560 Redundancy.

The ControlLogix® Redundancy System is a system that provides greater availability. The system has greater availability because it uses a redundant chassis pair. The redundant chassis pair maintains process operation when events, such as a fault on a controller, occur that stop process operation on non-redundant systems.

The redundant chassis pair includes two synchronized ControlLogix chassis with identically specific components in each. For example, one redundancy module and at least one ControlNet® or EtherNet/IP™ communication module are required.

Controllers are typically used in redundancy systems, but are not required if your application only requires communication redundancy. Your application operates from a primary chassis, but can switch over to the secondary chassis and components if necessary.

Features of the ControlLogix Redundancy System

The software and hardware components that are required to configure and use a ControlLogix redundancy system provide these features:

- Redundancy module speeds of up to 1000 Mbps when using a 1756-RM2 module with another 1756-RM2 module. Redundancy module speeds up to 100 Mbps when using a 1756-RM/A with another 1756-RM/A module, and a 1756-RM/B module with another 1756-RM/B module.
- The 1756-RM2 and 1756-RM2XT modules are interference-free regarding safety functions and can be used in ControlLogix SIL 2 applications. See the Using ControlLogix in SIL 2 Applications Safety Reference Manual, publication [1756-RMOOI](#).
- Redundant fiber ports for crossloading; no single point of failure of a fiber cable.
- Plug-and-play-style commissioning and configuration that does not require extensive programming.
- ControlNet and EtherNet/IP network options for the redundant chassis pair.

- Easy-to-use, fiber-optic communication cable that connects redundant chassis pairs. Use the same cable for the 1756-RM2 or 1756-RM/B modules.
- Simple redundant controller configuration by using a checkbox in the Controller Properties dialog box in the Studio 5000 Automation & Engineering Design Environment® programming software.
- A redundancy system ready to accept commands and monitor the redundant system states after basic installation, connection, and powerup.
- Switchovers occur as fast as 20 ms.
- Support for FactoryTalk® applications for Ethernet communication modules including, but not limited to:
 - FactoryTalk Alarms and Events
 - FactoryTalk Batch
 - FactoryTalk PhaseManager™
- Instruction Based Alarms (IBA) considerations:
 - 5560 supports up to 250 IBA's with 250 burst
 - 5570 supports up to 500 IBA's with 250 burst
 - For more information see the Knowledgebase Technote, [ALMA/ALMD instructions limits](#)
- Support for CIP Sync™ technology over an EtherNet/IP network to establish time coordination across the redundant system.
- Access to remote I/O modules over an EtherNet/IP network.
- Access to 1715 Redundant I/O systems over an EtherNet/IP network.
- Ethernet socket support.
- Support for PhaseManager.
- Supports PRP topologies. See the EtherNet/IP Parallel Redundancy Protocol Application Technique, publication [ENET-AT006](#).
- Supports DLR and topologies. See the EtherNet/IP Device Level Ring Application Technique, publication [ENET-AT007](#).

Features Not Supported

- Any motion feature
- Any SIL 3 functional safety feature within the redundancy controllers
- Firmware Supervisor
- SequenceManager™
- Event Tasks

IMPORTANT For Ethernet modules, signed and unsigned firmware are available. Signed modules provide the assurance that only validated firmware can be upgraded into a module.

Signed and unsigned firmware:

- Both signed and unsigned firmware are available.
- Product is shipped with unsigned firmware. To obtain signed firmware, you must upgrade the firmware for your product.
- To obtain signed and unsigned firmware, go to <http://www.rockwellautomation.com/global/support/firmware/overview.page>.
- Once signed firmware is installed, subsequent firmware updates must be signed also.

There are no functional/feature differences between signed and unsigned communication modules.

Controller Keyswitch

The position of the keyswitch on the controllers in both chassis must match (both in REM or both in RUN). There should NOT be a mismatch. See Knowledgebase Technote [Processor Key Switches in ControlLogix Redundancy System](#).

Primary Switch Position	Secondary Switch Position	Response on Switchover	
RUN	REM (Run)	Primary becomes secondary and synchronizes.	Secondary becomes primary with system in RUN mode.
REM (Run)	RUN	Primary becomes secondary and synchronizes.	Secondary becomes primary with system in RUN mode.
RUN	PROG	Primary becomes secondary and synchronizes.	Secondary becomes primary with system in PROGRAM mode.
REM (Run)	PROG	Primary becomes secondary and synchronizes.	Secondary becomes primary with system in PROGRAM mode.
PROG	REM (Run)	Primary becomes secondary and synchronizes.	Secondary becomes primary with system in PROGRAM mode.
REM (Program)	PROG	Primary becomes secondary and synchronizes.	Secondary becomes primary with system in PROGRAM mode.
PROG	RUN	Primary becomes secondary and does not synchronize.	Secondary becomes primary with major fault in new primary: <ul style="list-style-type: none"> • (Type 12) Redundancy Fault • (Code 34) Keyswitch in RUN invalid on switchover.
REM (Program)	RUN	Primary becomes secondary and does not synchronize.	Secondary becomes primary with major fault in new primary: <ul style="list-style-type: none"> • (Type 12) Redundancy Fault • (Code 34) Keyswitch in RUN invalid on switchover.

For more information on operation modes of the controller see *Choose the Controller Operation Mode* in the ControlLogix System User Manual, publication [1756-UM001](#).

Redundancy System Components

Communication between a redundant chassis pair that includes matching components makes redundancy possible.

Each chassis in the redundant chassis pair contains these ControlLogix components:

- One ControlLogix power supply - Required
- One ControlLogix redundancy module - Required
- Redundancy modules link the redundant chassis pair to monitor events in each of chassis and initiate system responses as required.
- At least one ControlLogix ControlNet or EtherNet/IP communication module - up to seven, optional (any combination)
- At least one controller - up to two controllers in the same family, optional
If the chassis is used as a redundant gateway, then a controller is not required.

In addition, redundant chassis are connected to other components outside the redundant chassis pair, for example, remote I/O chassis or human machine interfaces (HMIs).

For more information about components you can use in a redundancy system, see [Chapter 2, Design a ControlLogix Redundancy System on page 19](#).

I/O Modules in Redundancy Systems

In a redundancy system, you can only use I/O modules in a remote chassis. You **cannot use I/O modules in the redundant chassis pair**.

This table describes differences in network use for I/O in redundancy systems.

Remote I/O Module Placement	Available with Redundancy System, Revision 19 and Later	Available with Redundancy System, Revision 16 or Earlier
EtherNet/IP I/O network	X	-
ControlNet network	X	X
DeviceNet® network ⁽¹⁾	X	X
Data Highway Plus™ ⁽¹⁾	X	X
Universal remote I/O ⁽¹⁾⁽²⁾	X	X

(1) In a redundancy system, you can access remote I/O modules on this network only via a ControlNet or EtherNet/IP network bridge.

(2) 1756-DHRIO module must be used with a channel configured for RIO.

For more information on how to use remote and 1715 redundant I/O over an Ethernet network, see [I/O Placement on page 30](#) and the Redundant I/O System User Manual, publication [1715-UM001](#).

Redundancy System Operations

Once the redundancy modules in the redundant chassis pair are connected and powered, they determine which chassis is the primary chassis and which is the secondary chassis.

The redundancy modules in both the primary and secondary chassis monitor events that occur in each of the redundant chassis. If certain faults occur in the primary chassis, the redundancy modules execute a **switchover** to the unfaulted, secondary chassis.

System Qualification and Synchronization

When the redundant system is first started, the redundancy modules run checks on the redundant chassis. These checks determine if the chassis contain the appropriate modules and firmware to establish a redundant system. This stage of checks is referred to as **qualification**.

After the redundancy modules complete qualification, synchronization can take place. **Synchronization** is a state in which the redundancy modules execute these tasks:

- Verify that the connection between redundancy modules is ready to facilitate a switchover
- Verify that the redundant chassis continue to meet qualification requirements
- Synchronize the data between the redundant controllers, also called **crossloading**

This data is crossloaded:

- Updated tag values
- Forced values
- Online edits
- Other project information

Synchronization always takes place immediately following qualification. Also, depending on your system configuration, synchronization takes place at the end of each program that is run within the controller project, or at other intervals that you specify.

Switchovers

During redundant system operation, if certain conditions occur on the primary chassis, primary control is switched to the secondary chassis. These conditions cause a switchover:

- Loss of power
- Major fault on the controller
- Removal or insertion of any module
- Failure of any module
- Damage to a ControlNet cable or tap - This event only causes a switchover if it results in the ControlNet communication module transition to a lonely state, that is, the module does not see any devices on the network.
- Loss of an EtherNet/IP connection - This event only causes a switchover if it results in the EtherNet/IP communication module transition to a lonely state, that is, the module does not see any devices on the network.
- A program-prompted command to switchover
- A command that is issued via the Redundancy Module Configuration Tool (RMCT)

After a switchover occurs, the new primary controller continues to execute programs, which begin with the highest-priority task that had been executing on the previous primary controller.

For more information about how tasks execute after a switchover, see [Crossloads, Synchronization, and Switchovers on page 96](#).

Your application can require some programming considerations and potential changes to accommodate a switchover. For more information on these considerations, see [Chapter 7, Program the Redundant Controller on page 93](#).

IMPORTANT During a switchover of the fiber channels of the 1756-RM2 module, scan time encounters a delay of ~10 ms; however, the chassis always remains synched.

Data Server Communication Recovery Time Reduction During a Switchover

Brief communication interruption occurs between FactoryTalk Linx software and the redundant chassis pair when a switchover occurs. After the switchover is complete, communication resumes automatically.

Data server communication recovery time is the time during a switchover from primary to secondary, when tag data from the controller is unavailable for reading or writing. Data server communication recovery time applies to any software that uses tag data, such as HMI displays, data loggers, alarms systems, or historians. Data server communication recovery time reduction is important to increase the availability of the system.

IMPORTANT

- Prior to firmware revision 30.051, the communication delays apply only when communication is exclusively over EtherNet/IP networks.
- With firmware revision 30.051 or later, the communication delays apply to both EtherNet/IP and ControlNet networks.

IMPORTANT FactoryTalk Linx software is part of FactoryTalk Services, which has been releasing a series of Service Releases (SRs) that are backward compatible with any CPR 9 products. Existing and new users who are using FactoryTalk View version 5.0 (CPR9) or later can use the data server communication recovery time feature.

As of revision 31.052, the communication delays over Ethernet during a switchover event have been reduced significantly. When you configure the connection between a FactoryTalk Linx data server, and a redundant ControlLogix controller, you can configure redundant shortcut paths to the primary and secondary controllers. These shortcut paths help reduce data server communication recovery time that occurs during a redundancy switchover.

The following are required to take advantage of this:

- A dedicated pair of ControlLogix Communication Modules with firmware revision 11.001 or later (1756-EN2TP, 1756-EN2TR, 1756-EN2T), that do not swap IP addresses. See [Do Not Use IP Address Swapping on page 56](#).
- ControlLogix 5570 redundancy controllers with redundancy firmware revision 31.052 or later
- FactoryTalk Linx 6.00 with the FactoryTalk Linx patch available from Rockwell Automation Knowledgebase Technote [Patch: FactoryTalk Linx 6.00 patch required to support ControlLogix V31.05 Redundancy](#), or later versions of FactoryTalk Linx.
- Redundant ControlLogix Controller shortcut type in FactoryTalk Linx that points to the Primary and Secondary controllers through the communication modules, without swapping IP addresses. For information on shortcuts in FactoryTalk Linx, see the FactoryTalk Linx Getting Results Guide, publication [LNXENT-GRO01](#).

Some communication delays can occur during qualification. The existence and duration of these delays depend on:

- Quantity and types of tags on scan in FactoryTalk Linx software
- Client screen and tag update rates (e.g. FactoryTalk Live Data/ FactoryTalk Historian)
- Number of data subscribers (i.e. FactoryTalk Alarms and Events, FactoryTalk Batch)
- Size of the application in the redundant controller
- Controller loading, which includes the following:
 - Number of tasks and scan rates (assumes no continuous task)
 - Number of programs
 - Memory usage
 - Null task percentage available
 - Network traffic

Restrictions

There are restrictions that you must consider when using a redundancy system. Most of these restrictions apply to all redundancy system revisions. Exceptions are noted:

- See the release notes of the redundancy bundles for compatible products, versions, and revisions
- The redundant controller program cannot contain these tasks:
 - Event tasks
 - Inhibited tasks

For recommendations and requirements that are related to programming the redundant controller, see [Program the Redundant Controller on page 93](#).

- You cannot use the Match Project to Controller feature available in Studio 5000 Logix Designer® in a redundancy system.
- You cannot use motion in a redundant controller program.
- You cannot use SequenceManager.
- You cannot use consumed unicast connections in a redundancy system. If you attempt to use consumed unicast connections, disqualification occurs and qualification of an unsynchronized redundant chassis pair is not allowed. You can use produced unicast connections that remote consumers consume.
- Outputs controlled by specific instructions are not guaranteed to maintain a bumpless transition during a switchover. Due to this, it is recommended to avoid using the following instructions within a redundancy system:
 - IOT
 - HMIBC
- You can use a maximum of two controllers of the same family, and seven ControlNet or EtherNet/IP communication modules in each chassis of a redundant chassis pair.
- You can execute the tasks that were supported previously in a redundancy system, revision 19.052 or greater.

This graphic shows an example ControlLogix redundancy system, revision 19.053 or greater, which uses EtherNet/IP networks.

Figure 1 - Example ControlLogix Redundancy System using an EtherNet/IP Network

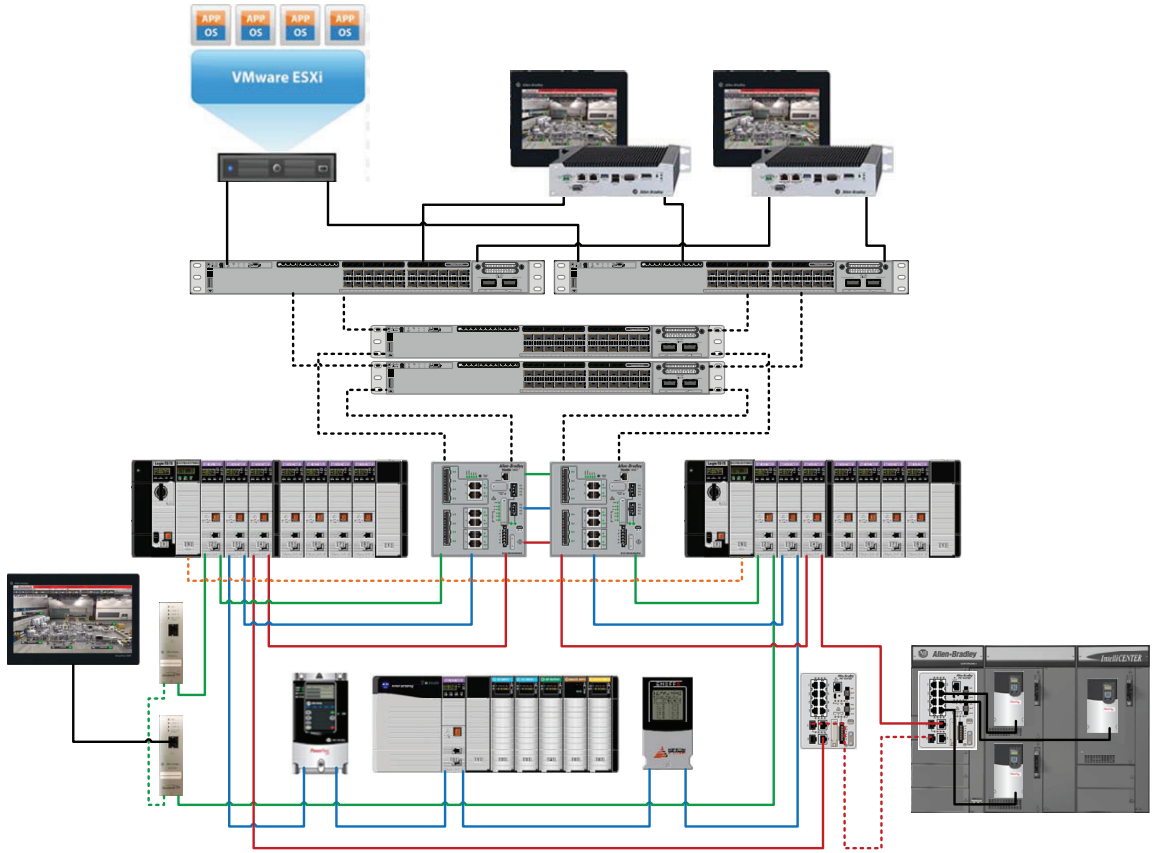

Design a ControlLogix Redundancy System

Topic	Page
Redundant Chassis	19
Controllers in Redundant Chassis	20
EtherNet/IP Networks with Redundant Systems	24
ControlNet Networks with Redundant Systems	25
Other Communication Networks	29
I/O Placement	30
Using HMI	32
Optional Software	34

This chapter explains how to use the required and optional components to design a redundancy system.

IMPORTANT There are module series level, firmware revision, and software version requirements for redundancy systems. For more information on these module series level, firmware revision, and version requirements, see the current release notes at: <http://www.rockwellautomation.com/global/literature-library/overview.page>

Redundant Chassis

You can use any ControlLogix® or ControlLogix-XT™ chassis in a redundant chassis pair as long as the two chassis that are used are the same size. For example, if the primary chassis in your redundant chassis pair uses a 1756-A4 chassis, the secondary chassis must use a 1756-A4 chassis.



When using 1756-L72, 1756-L73, 1756-L74, or 1756-L75 Redundant controllers in your system, you must use firmware revision 19.053 or greater. When using a 1756-L71 Redundant controller, you must use firmware 20.054 or greater.

Redundant Chassis Configuration Requirements

These configuration parameters must match for the components in a redundant chassis pair during normal system operation:

- Module type
- Chassis size
- Slot placement
- Firmware revision
- Series level. See [page 22](#)

Figure 2 - Example of Redundant Chassis Pair

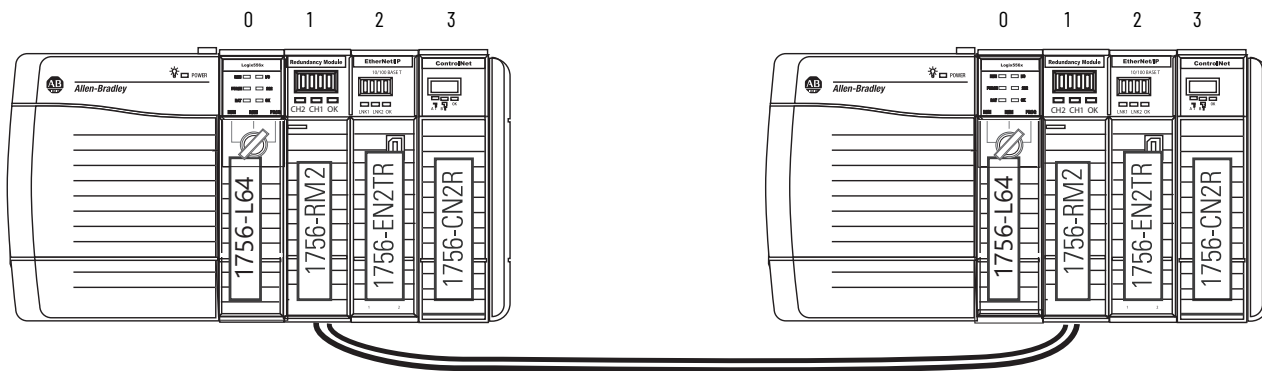

Controllers in Redundant Chassis

Remember these points when you place controllers in the redundant chassis pair:

- Controllers are typically included, but not required, in redundancy systems. If you have a redundancy system without controllers, you have only a redundant gateway rack.
- You can place up to two controllers in the same chassis. When you use two controllers in the same chassis, they must be of the same product family. The series of the controller in the primary and secondary chassis do not need to match.

For example, you cannot place a ControlLogix 5560 controller and a ControlLogix 5570 controller in the same chassis.

IMPORTANT When using a ControlLogix redundancy system, revision 16.081 or earlier, you cannot use two 1756-L64 controllers in the same chassis. You can, however, use a 1756-L64 controller in the same chassis as a 1756-L61, 1756-L62, or 1756-L63 controller.

- You can use different catalog numbers from the same product family in the same chassis. For example, you can use two ControlLogix 5560 controllers in a chassis.
- Each ControlLogix 5560/5570 controller must have enough data memory to store twice the amount of tag data that is associated with a redundant controller project.



ControlLogix 5580 controllers that are enabled for redundancy do not have memory constraints. ControlLogix 5580 controllers that are enabled for redundancy experience no reduction in memory from a standard use ControlLogix 5580 controller.

- Each controller must have enough I/O memory to store twice the amount of I/O memory used. To check the I/O memory that is used and available, access the Memory tab of the Controller Properties dialog box in the programming software.

For more information about data and I/O memory, see the Knowledgebase Technote [Understanding ControlLogix Redundancy Memory Usage](#).

- When you use the redundancy system update (RSU) feature to update a redundancy system while the system continues operation, the updated controllers must provide the same or greater memory than the existing controllers.

This table describes the controllers to which you can upgrade, based on the existing controller that is used, when using RSU.

Existing	New Controller
1756-L61	1756-L61, 1756-L62, 1756-L63, 1756-L64, 1756-L65
1756-L62	1756-L62, 1756-L63, 1756-L64, 1756-L65
1756-L63	1756-L63, 1756-L64, 1756-L65
1756-L64	1756-L64, 1756-L65
1756-L65	1756-L65
1756-L71	1756-L71, 1756-L72, 1756-L73, 1756-L74, 1756-L75
1756-L72	1756-L72, 1756-L73, 1756-L74, 1756-L75
1756-L73	1756-L73, 1756-L74, 1756-L75
1756-L74	1756-L74, 1756-L75
1756-L75	1756-L75

Differences in controller types between chassis can exist only during the system upgrade process. When you complete the system upgrade, the controllers in the redundant chassis pair **must match** for the system to synchronize.

Plan for Controller Connections

Consider these conditions when you plan controller connection use:

- **ControlLogix 5560 controllers** provide **250 total connections**.
- **ControlLogix 5570 controllers** provide **500 total connections**.

If you use the redundant controller at, or very near the connection limits, you can experience difficulty synchronizing your chassis.

Redundancy Modules in Redundant Chassis

Two redundancy modules, one in each chassis of the redundant chassis pair, jointly supervise the control system operating states and transitions, which establishes the framework for system redundancy. This bridge between chassis facilitates the exchange of control data and synchronization of operations.

The redundancy modules let you commission the redundant system in a plug-and-play manner without any programming. You connect a redundancy module pair with the default configuration in the redundant chassis pair and configure the redundant system.

You can establish redundancy between chassis in either of these manners:

- Insert a redundancy module pair into two powered chassis that contain redundancy-compliant components and redundancy-enabled application programs, and then connect the redundancy modules.
- Insert and connect the redundancy modules in two chassis and then insert redundancy-compliant components into each chassis.

IMPORTANT You are not required to develop any programming to migrate from a non-redundant to a redundancy system if your application meets these conditions:

- Your application meets the points that are listed in [Restrictions on page 17](#).
- The controller properties dialog box in your project has Redundancy enabled.

Once the redundant chassis pair contains all desired components and is powered, no further tasks are required in the redundancy modules to activate system redundancy. The redundancy modules automatically determine the operational state of each of the chassis pair and are ready to accept commands and provide system monitoring.

Communication Modules in Redundant Chassis

Remember these points when placing ControlLogix ControlNet® and EtherNet/IP™ communication modules in the redundant chassis pair:

- You must use enhanced communication modules in redundancy systems. Enhanced communication modules contain a '2' in their catalog number. For example, the 1756-EN2T module.
- Standard ControlNet and EtherNet/IP communication modules are not supported. Standard communication modules contain a 'B' in their catalog number. For example, the 1756-ENBT module.
- You can use the **1756-EN2TR** module only with a redundancy system, **revision 19.052** or later.
- You can use the **1756-EN2F** module only with a redundancy system, **revision 20.054** or later.
- You can use the **1756-EN2TP** module only with a redundancy system, **revision 31.052** or later.
- You can use any combination of up to seven enhanced communication modules in each redundant chassis.
- If you use a ControlNet network in your redundant chassis pair, you must have two ControlNet communication modules outside the redundant chassis pair. When you assign node address numbers, assign the lowest node number address to a ControlNet communication module outside the redundant chassis pair.

For more information, see [Use at Least Four ControlNet Network Nodes on page 26](#) through [Assign Lowest Node Numbers to Remote ControlNet Modules on page 26](#).

- You cannot use Series A ControlNet communication modules in a redundancy system.
- The Series for EtherNet/IP communication modules is not required to match in a partnered set. However, the firmware levels must be the same in a partnered set. Also, if your application requires a feature specific to a module series level, you must use the same series level for each module in a partnered set.

For example, only the 1756-EN2T/C communication module only offers the double-data rate (DDR) feature. You must use 1756-EN2T/C modules in each chassis of the redundant chassis pair to use DDR.

- **Do not use the USB ports** of communication modules to access the redundant system network while the system is running, that is, online. Use of the USB ports while online can result in a loss of communication after a switchover.

Plan for Communication Module Connections

A CIP™ connection is a point-to-point communication mechanism that is used to transfer data between a producer and a consumer. These mechanisms are examples of CIP connections:

- Logix 5000® controller message transfer to Logix 5000 controller
- I/O or produced tag
- Program upload
- RSLinx® DDE/OPC client
- PanelView™ polling of a Logix 5000 controller

ControlLogix **ControlNet communication modules** provide 131 total CIP connections. Consider these points when using CIP connections with ControlLogix ControlNet communication modules:

- Three of the 131 CIP connections are reserved for redundancy. The three redundant-system CIP connections always appear to be in use, even when no connections are open.
- You can use the remaining 128 CIP connections in any manner that your application requires, such as the examples listed previously.

ControlLogix **EtherNet/IP communication modules** provide 259 total CIP connections. Consider these points when using CIP connections with ControlLogix EtherNet/IP communication modules:

- Three of the 259 CIP connections are reserved for redundancy.
- You can use the remaining 256 connections in any manner that your application requires, such as the examples listed previously.

Power Supplies and Redundant Power Supplies in Redundancy Systems

Redundancy systems can use standard power supplies. You can choose to use redundant power supplies to maintain power to a ControlLogix chassis if one of the supplies loses power. Use these hardware components to connect redundant power supplies:

- Two redundant power supplies for each chassis
- One 1756-PSCA chassis adapter for each redundant chassis
- Two 1756-CPR cables for each redundant chassis to connect the power supplies to the 1756-PSCA adapter
- Optional, user-supplied annunciator wiring to connect the power supplies to remote input modules

Figure 3 - Redundant Power Supplies with Redundant Chassis

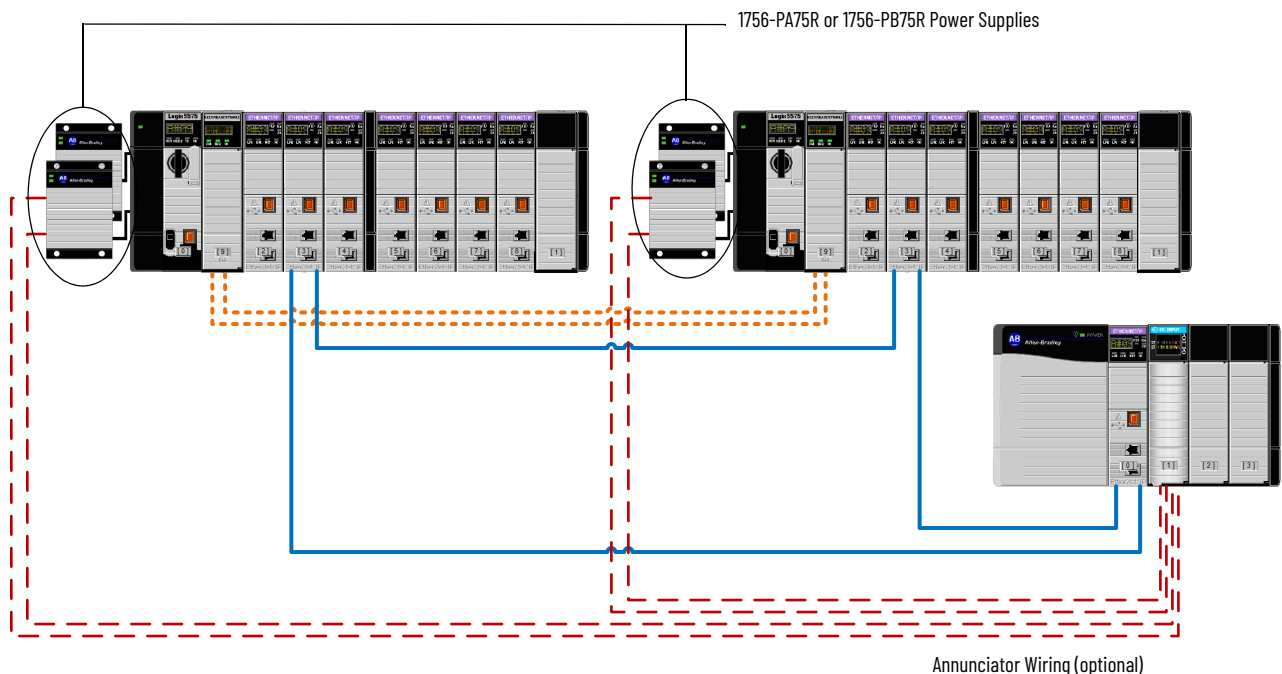

For more information about redundant power supplies, see the ControlLogix System Selection Guide, publication [1756-SG001](#).

EtherNet/IP Networks with Redundant Systems

The use of EtherNet/IP networks in a redundancy system is primarily dependent on your system revision.

IMPORTANT A remote chassis can be accessed over an EtherNet/IP network by using any EtherNet/IP module that works in a non-redundant chassis with no additional firmware requirement with the following exception. If the remote chassis contains a controller that consumes a tag that is produced in the redundant chassis pair, it can only consume the tag with the required firmware revisions.

For more information on how to use an EtherNet/IP network in your redundancy system, see [Configure the EtherNet/IP Network on page 55](#).

Unicast Functionality

Redundancy systems support unicast produced tags. Unicast consumed tags are **not supported** in redundancy systems. Unicast I/O is **not supported** in a redundancy system.

Possible Communication Delays on EtherNet/IP and ControlNet Networks

The connection between a component and the redundant chassis pair can experience brief communication delays during a switchover. After the switchover is complete, communication resumes automatically.

These connection types can experience the communication delay when the switchover occurs:

- HMI to redundant chassis pair
- FactoryTalk® Batch server to redundant chassis pair
- FactoryTalk Alarms and Events Service to redundant chassis pair

IMPORTANT

- Prior to firmware revision 30.051, the communication delays apply only when communication is exclusively over EtherNet/IP networks.
- With firmware revision 30.051 or later, the communication delays apply to both EtherNet/IP and ControlNet networks.

Bridge from an EtherNet/IP Network to a ControlNet Network

Bridge from an EtherNet/IP network to a ControlNet network if you must maintain the connection between the component and a redundant chassis pair during a switchover.

IMPORTANT You can bridge from an EtherNet/IP network to a ControlNet network to maintain the connection between the component and a redundant chassis only in redundancy firmware revisions prior to revision 30.051. I/O connections are not supported in any bridge configurations in any version.

See [Data Server Communication Recovery Time Reduction During a Switchover on page 15](#).

This example graphic shows the recommended method to connect an HMI to a redundant chassis pair if connection drops are a concern in your application. In this graphic, the remote chassis contains I/O modules and the EtherNet/IP and ControlNet communication modules. The I/O modules are not required and are shown for example only. For all requirements, see [ControlNet Networks with Redundant Systems on page 25](#).

Figure 4 - Configuration Used to Eliminate Communication Delays on Switchover

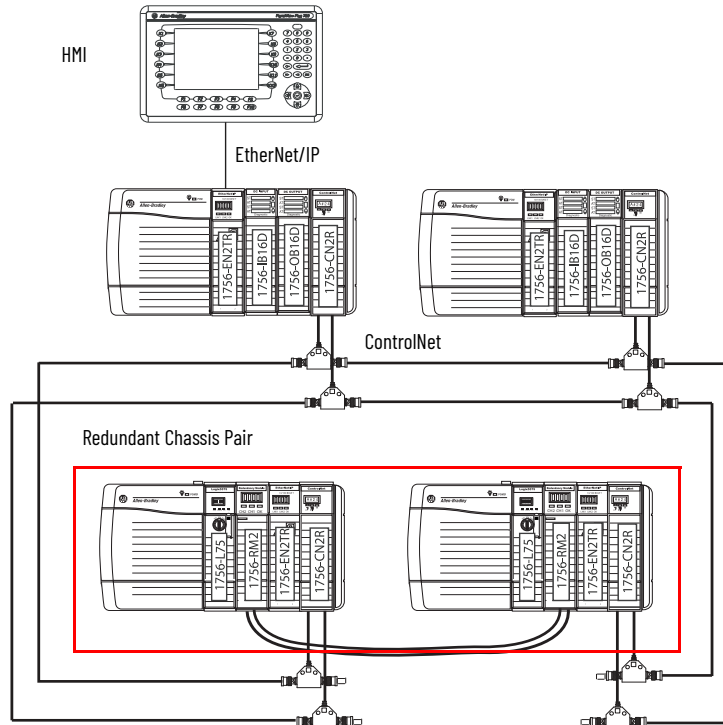

ControlNet Networks with Redundant Systems

ControlNet networks are used to connect redundant controller chassis to remote I/O and to other devices in the system.

IMPORTANT A remote chassis can be accessed over a ControlNet network that uses any ControlNet module that works in a non-redundant chassis with no additional firmware requirement.

ControlNet Network Requirements

If you use a ControlNet network in your redundancy system, you must consider the following:

- [Use at Least Four ControlNet Network Nodes](#)
- [Assign Lowest Node Numbers to Remote ControlNet Modules](#)
- [Set Partnered ControlNet Module Switches to the Same Address](#)
- [Reserve Consecutive Node Addresses for Partner Modules](#)

Use at Least Four ControlNet Network Nodes

With redundant systems, at least four ControlNet network nodes are required per ControlNet network. This configuration is required because two or more ControlNet nodes must be used with the two ControlNet modules that are used in the redundant chassis. One of the two nodes outside of the redundant chassis must be at a lower node address than the ControlNet modules in the redundant chassis.

If your ControlNet uses fewer than four nodes, and a switchover occurs, connections can drop and outputs connected to that node can change state during the switchover.

You can include these ControlNet modules and redundant ControlNet nodes:

- ControlNet bridges in remote chassis
- Any other ControlNet devices on the ControlNet network
- A workstation running communication software that is connected via a ControlNet network

For more information, see Knowledgebase Technote [ControlNet Network Keeper and ControlLogix Redundancy](#).

Assign Lowest Node Numbers to Remote ControlNet Modules

Do not assign the lowest ControlNet node addresses to ControlNet modules in the redundant chassis pair.

If you assign the lowest ControlNet node addresses to ControlNet modules in the redundant chassis pair, you can experience these system behaviors:

- Upon a switchover, you can lose communication with I/O modules, produced tags, and consumed tags.
- If you remove a ControlNet module from the redundant chassis, it can result in lost communication with I/O modules, produced tags, and consumed tags.
- If the entire system loses power, you can be required to cycle power to the primary chassis to restore communication.

Set Partnered ControlNet Module Switches to the Same Address

Where ControlNet modules are used as partners in a redundant chassis pair, you must set the node address switches to the same node address. The primary ControlNet modules can be at even or odd node addresses.

For example, if partnered ControlNet modules are assigned to nodes 12 and 13 of the ControlNet network, set the node address switches of the modules to the same address of 12.

Figure 5 - Example of Switch Address for Partnered ControlNet Modules

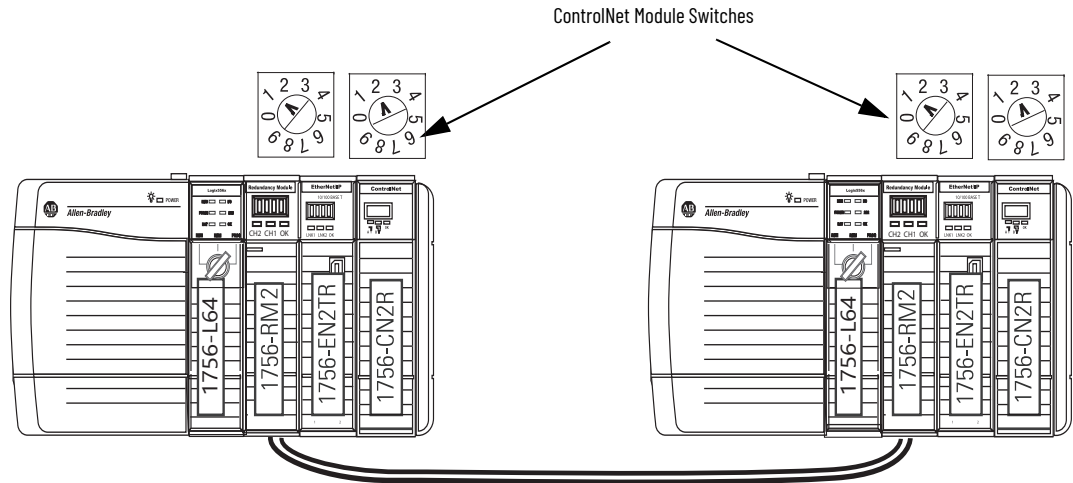

Reserve Consecutive Node Addresses for Partner Modules

Where ControlNet modules are used as partners in redundant chassis, plan consecutive node numbers for those partnered modules. Plan for consecutive node addresses because the redundant system automatically assigns the consecutive node address to the secondary ControlNet module.

For example, partnered ControlNet modules with address switches set at 12 are assigned ControlNet node numbers 12 and 13 by the system.



The primary chassis always assumes the lower of the two node addresses.

Figure 6 - Example of Redundant ControlNet Modules at Consecutive Addresses

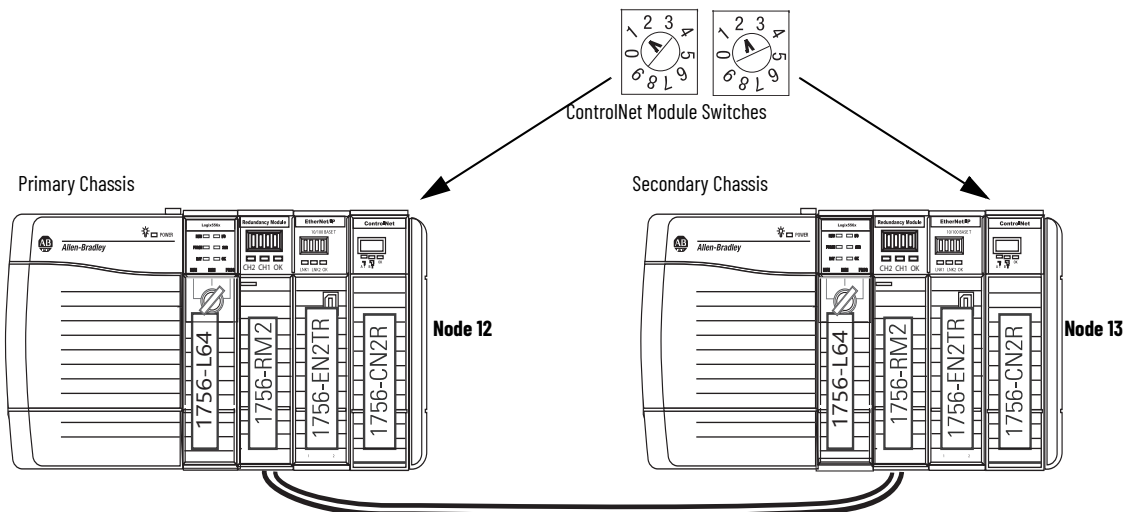

Redundant ControlNet Media

The use of redundant ControlNet media helps to prevent a loss of communication if a trunkline or tap is severed or disconnected. A system that uses redundant ControlNet media uses these components:

- 1756-CN2R, series B or later, communication modules in each redundant chassis
- ControlNet modules that are designed for redundant media at each ControlNet node on the network
- Redundant trunk cabling
- Redundant tap connections for each ControlNet module connected

Figure 7 - Redundant ControlNet Media with Redundant ControlLogix Chassis

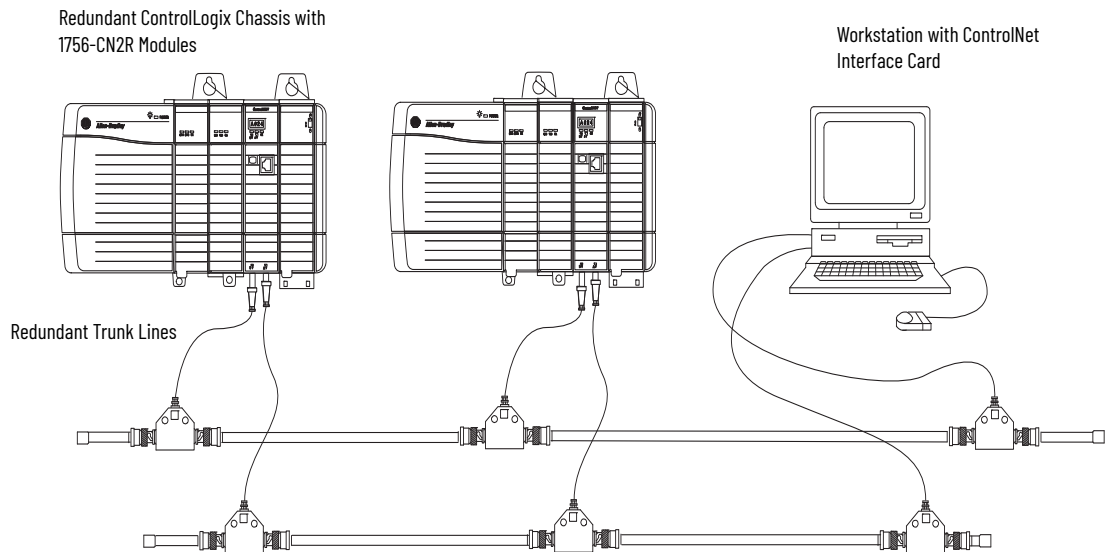

Other Communication Networks

You can use only EtherNet/IP and ControlNet networks, and corresponding modules, in the local chassis for redundancy systems.

IMPORTANT Do not use the redundant chassis to bridge between networks. Bridging through the redundant chassis to the same or different networks, or routing messages through redundant chassis is not supported.

You can bridge to other communication networks outside of the redundant chassis. You can bridge these networks via a remote chassis:

- DeviceNet
- Universal remote I/O
- Data Highway Plus™

Figure 8 - Example of Bridging to Remote I/O on Various Networks

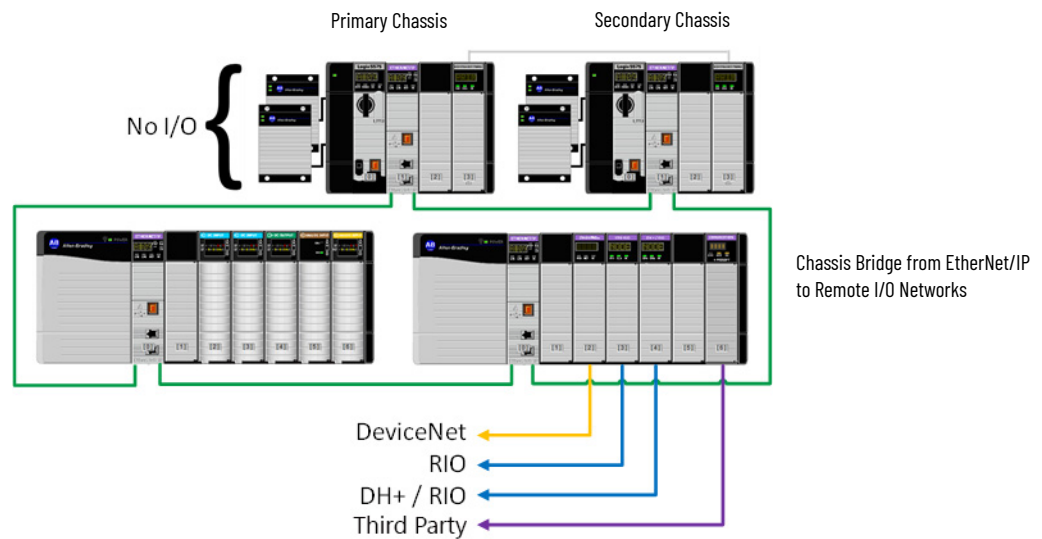

This table indicates what system components to use with each network that is connected to a redundant system.

Table 1 - Communication Networks Available for Use with Redundancy Systems

Network	Connection to Redundant System	Component	
		I/O	HMI
ControlNet	Directly to redundant chassis	Yes	Yes
	Via a bridge	No	Yes
DeviceNet	Via a bridge	Yes	Yes
EtherNet/IP	Directly to redundant chassis	Yes - Redundancy System, Revision 19.052 or later	Yes ⁽¹⁾
	Via a bridge	No	Yes
Universal remote I/O	Via a bridge	Yes	Yes
Data Highway Plus	Via a bridge	Yes	Yes

(1) Prior to redundancy firmware revision 30.051, you can connect the HMI to the redundant chassis pair via a bridge from an EtherNet/IP network to a ControlNet network to help prevent a brief loss of communication with the redundant chassis pair if a switchover occurs. For more information, see [Possible Communication Delays on EtherNet/IP and ControlNet Networks on page 24](#).

I/O Placement

In a redundancy system, you can place I/O modules in these locations:

- Same ControlNet network as redundant controllers and communication modules
- Same EtherNet/IP network as redundant controllers and communication modules
- DeviceNet network that is connected via a bridge
- Universal remote I/O network that is connected via a bridge

IMPORTANT You **cannot** install I/O modules in the redundant chassis pair. You can only install I/O modules in remote locations that are accessed over the networks in this list.
You can connect to remote I/O modules over an EtherNet/IP network in a redundancy system, **revision 19.052 or later**.

1715 Redundant I/O Systems

With a redundancy system revision 19.052 or greater, you can connect to 1715 Redundant I/O systems over an EtherNet/IP network.

The 1715 Redundant I/O system provides high availability and redundancy for critical processes by using a redundant adapter pair and multiple I/O modules that have diagnostics and are easily replaceable.

The 1715 Redundant I/O system consists of one, two-slot, adapter base unit that houses a redundant adapter pair. The adapter base unit is connected to up to 8, three-slot, I/O base units, which can hold up to 24 fully configurable digital and analog I/O modules. You can configure a 1715 Redundant I/O system in a Ring or Star topology.

Each 1715 Redundant I/O system uses one IP address as the primary IP address for all communication. The redundant adapter pair consists of two active modules, a primary adapter and its partner, a secondary module.

For more information about the 1715 Redundant I/O system, see the Redundant I/O System User Manual, publication [1715-UM001](#).

Figure 9 - Example of I/O Placement Options

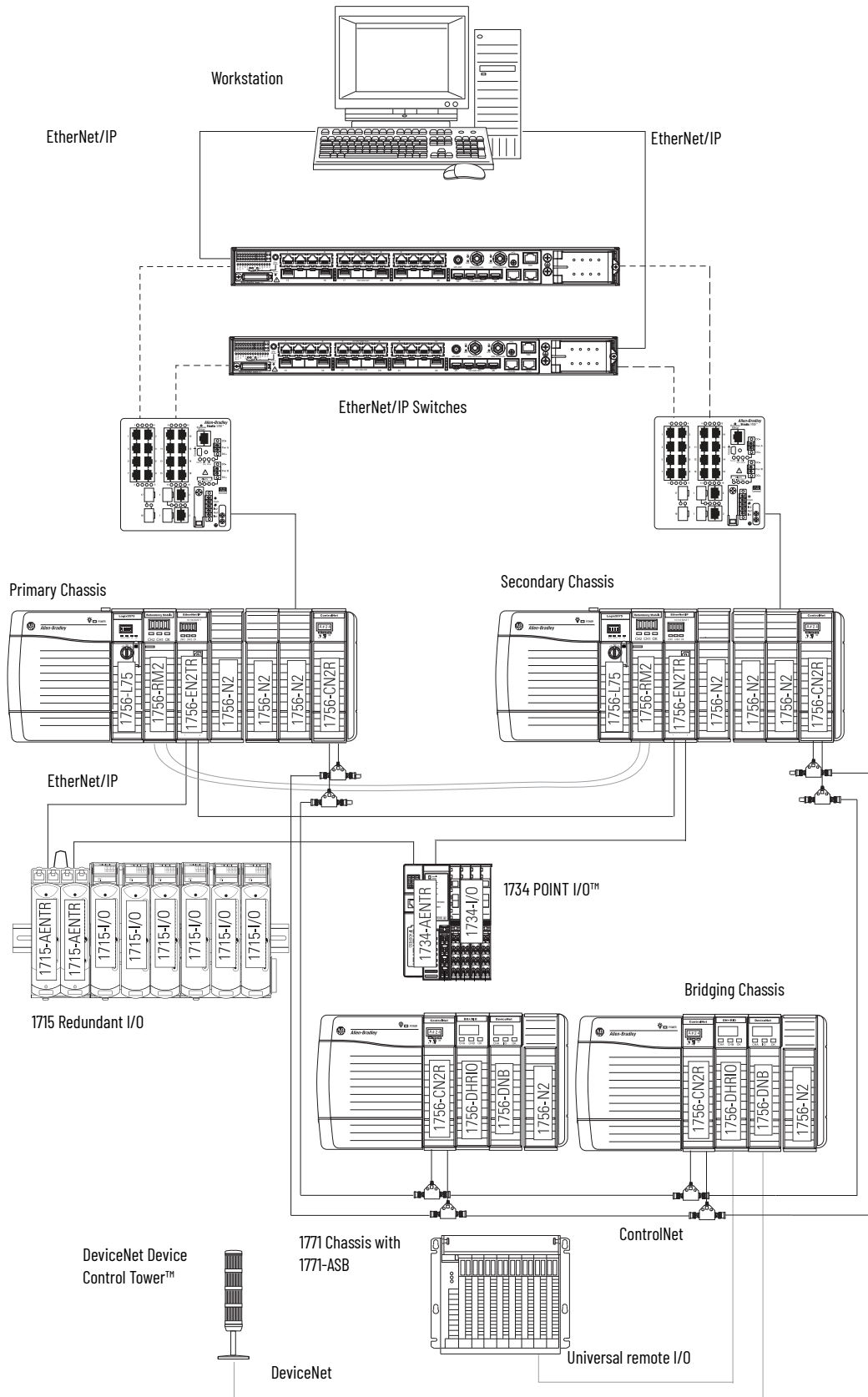

Using HMI

Depending on the network that is used to connect the redundant system to HMIs, plan for certain placement and configuration requirements. You can connect an HMI to a primary chassis over either of these networks:

- EtherNet/IP
- ControlNet

IMPORTANT Do NOT target active communications at the secondary chassis, anomalous behavior may result.

HMI Connected Via an EtherNet/IP Network

This table describes redundant system considerations specific to the HMI being used on the EtherNet/IP network.

Type of HMI Used	Considerations						
PanelView Standard terminal	Same as a non-redundant system.						
<ul style="list-style-type: none"> • PanelView Plus terminal • VersaView® industrial computer that runs the Windows CE operating system 	<ul style="list-style-type: none"> • Use FactoryTalk Linx software, version 5.0 or later. • Set aside connections for each PanelView Plus or VersaView CE terminal as indicated in this table. <table border="1" style="margin-left: auto; margin-right: auto;"> <thead> <tr> <th>In this module</th> <th>Reserve</th> </tr> </thead> <tbody> <tr> <td>Controller</td> <td>5 connections</td> </tr> <tr> <td>1756-EN2T</td> <td>5 connections</td> </tr> </tbody> </table>	In this module	Reserve	Controller	5 connections	1756-EN2T	5 connections
In this module	Reserve						
Controller	5 connections						
1756-EN2T	5 connections						
FactoryTalk View Site Edition software with FactoryTalk Linx software	<ul style="list-style-type: none"> • Use FactoryTalk Linx communication software, version 5.0 or later. • Keep the HMI and both redundant chassis on the same subnet. • Configure the network to use IP swapping. 						
<ul style="list-style-type: none"> • FactoryTalk View Site Edition software with RSLinx Classic software, version 2.52 or later • RSView®32 software • Any other HMI client software that uses RSLinx Classic software, version 2.52 or later 	Limit the number of RSLinx servers that a controller uses to 1...3 servers, where the use of one server is ideal.						

HMI connected to a redundant chassis pair exclusively over an EtherNet/IP network can briefly drop the connection when a switchover occurs. The connection is re-established, however, after the switchover is complete.

HMI Connected Via a ControlNet Network

This table describes redundant system considerations specific to the HMI being used on the ControlNet network.

Type of HMI Used	Considerations						
<ul style="list-style-type: none"> PanelView Standard terminal PanelView 1000e or PanelView 1400e terminal 	<ul style="list-style-type: none"> If your HMI communicates via unscheduled communication, use four terminals per controller. If your HMI does not communicate via unscheduled communication, use the number of terminals that are required for your application. 						
<ul style="list-style-type: none"> PanelView Plus terminal VersaView industrial computer that runs the Windows CE operating system 	<p>Set aside connections for each PanelView Plus or VersaView CE terminal.</p> <table border="1"> <thead> <tr> <th>In this module</th> <th>Reserve</th> </tr> </thead> <tbody> <tr> <td>Controller</td> <td>5 connections</td> </tr> <tr> <td>1756-CN2⁽¹⁾, 1756-CN2R⁽¹⁾</td> <td>5 connections</td> </tr> </tbody> </table> <p>(1) You can use series B or later modules.</p>	In this module	Reserve	Controller	5 connections	1756-CN2 ⁽¹⁾ , 1756-CN2R ⁽¹⁾	5 connections
In this module	Reserve						
Controller	5 connections						
1756-CN2 ⁽¹⁾ , 1756-CN2R ⁽¹⁾	5 connections						
<ul style="list-style-type: none"> FactoryTalk View Site Edition software with RSLinx Classic software, version 2.52 or later RSView32 software Any other HMI client software that uses RSLinx Classic software, version 2.52 or later 	<p>Limit the number of RSLinx servers that a controller uses to 1 (ideal) to 3 (maximum).</p>						

For redundancy firmware revisions earlier than revision 30.051, an HMI connected to a primary chassis exclusively over a ControlNet network or bridge from an EtherNet/IP network to a ControlNet network maintains its connections during a switchover.

For redundancy firmware revisions 30.051 or later, HMI connections are no longer maintained on switchover with communications over ControlNet. After the switchover is complete, the connection is re-established. This causes a FactoryTalk Batch server to go to a held state.

Figure 10 shows an example of how to connect an HMI to a primary controller over a ControlNet network.

Figure 10 - Connection from HMI Over a ControlNet Network

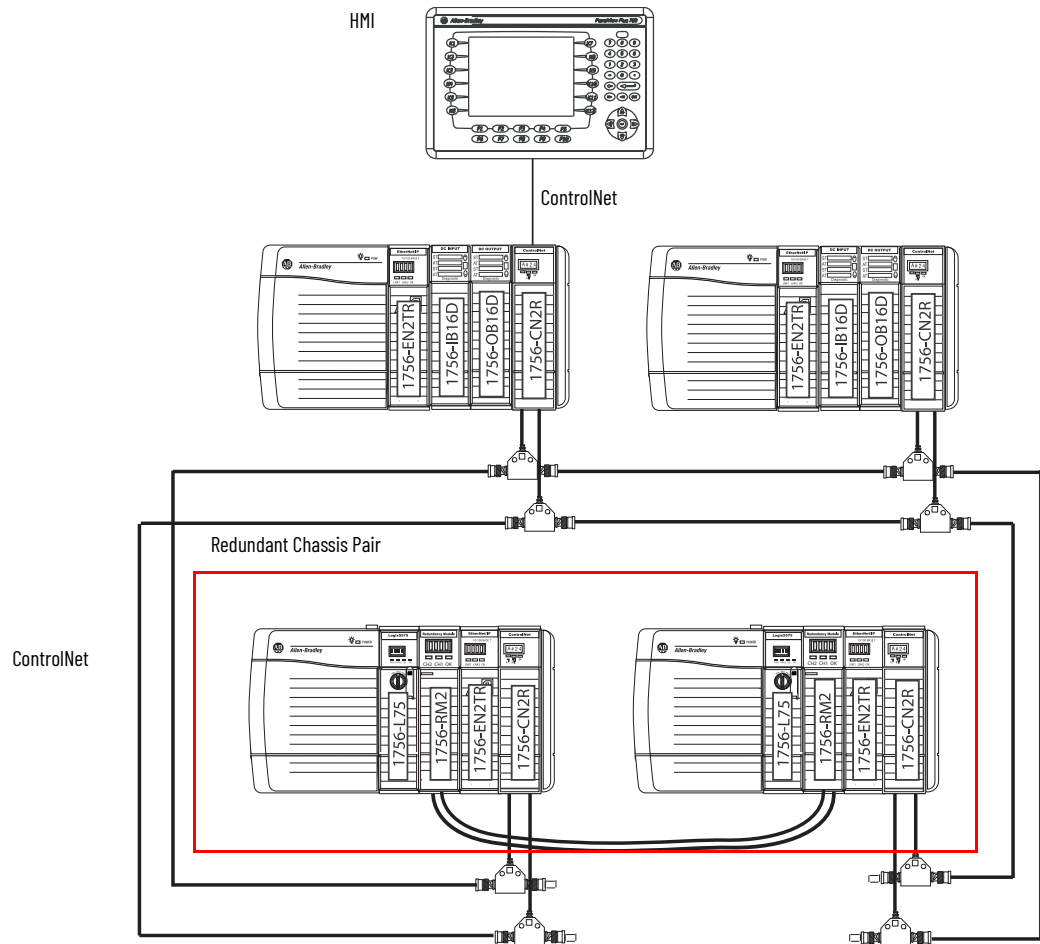

For an example of how to connect an HMI to a redundant chassis pair over a path that bridges from an EtherNet/IP network to a ControlNet network, see [Bridge from an EtherNet/IP Network to a ControlNet Network on page 24](#).

Optional Software

Optional software can be needed depending on your redundancy system program, configuration, and components. Optional software is listed in the following table.

If using	Then use this software
ControlNet network	RSNetWorx™ for ControlNet
EtherNet/IP network	RSNetWorx for EtherNet/IP
Alarms	FactoryTalk Alarms and Events
Batches or recipes	FactoryTalk Batch
HMI ⁽¹⁾	<ul style="list-style-type: none"> FactoryTalk View Site Edition FactoryTalk View Machine Edition FactoryTalk Linx software RSView32
Various FactoryTalk services	FactoryTalk Services Platform

(1) See [Using HMI on page 32](#) for additional information.

Install the Redundancy System

Topic	Page
Before You Begin	35
Redundancy System Quick Start	35
Install the Hardware	37
Connect the Redundancy Modules	43
Update Redundant Firmware	48
Designate the Primary and Secondary Chassis	50

Before You Begin

Complete these tasks before you install the redundancy system:

- Verify that you have the components that are required to install your system.
- Read and understand the safety and environmental considerations explained in the installation instruction publication for each component.
- Order a 1756-RMCx fiber-optic communication cable if you do not have one.
- If you choose to make your own fiber-optic cable for lengths that the 1756-RMCx catalog numbers do not support, refer to [Fiber-optic Cable on page 46](#).

Redundancy System Quick Start

See these Quick Start steps when configuring your system for the first time.

1. Review the release notes for the firmware bundle that you are installing. Make sure that you have compatible hardware and the correct firmware revisions.
2. Install/update the workstation software and firmware bundle. Software applications that are needed include:
 - Studio 5000 Logix Designer® application
 - Communication software
 - Redundancy Module Configuration Tool (RMCT). See [Install the Hardware on page 37](#)

IMPORTANT If communication software is already on your system, make sure to shut it down before installing/upgrading software.

3. To begin the hardware installation, determine the location of your modules in the chassis of the system. Plug in the communication modules, controller, and redundancy modules into the chassis, matching partners slot for slot.
Install the following:
 - The first chassis and power supply, see [page 37](#).
 - The first chassis communication modules.
 - a. Determine the IP address for your Ethernet communication modules. Both Ethernet communication modules of the same pair have the same IP address.
 - b. Set both Ethernet communication modules to the same IP address. (This rule also applies to ControlNet® networks for node addresses.) See [Configure the EtherNet/IP Network on page 55](#).
 - The first chassis controller.
 - The first chassis redundancy module, see [page 37](#).
 - The second chassis, power supply, communication modules, controller, and redundancy module. See [page 43](#).
4. Plug in the fiber-optic communication cable to connect the redundancy modules in both chassis. See [Connect the Redundancy Modules on page 43](#).
5. Upgrade the firmware of the redundant chassis modules. See [Update Redundant Firmware on page 48](#).
 - a. Apply power to the first chassis.
 - b. Launch ControlFLASH™ or ControlFLASH Plus™ software and upgrade the firmware.
 - c. Upgrade the firmware of the redundancy module and verify that the status is PRIM.
 - d. Update all remaining modules in the chassis using ControlFLASH or ControlFLASH Plus software.
 - e. Power off the first chassis.
 - f. Power on the second chassis.
 - g. Follow the same update process as the first chassis.
 - h. Power off the second chassis.
6. Designate the primary chassis. See [Designate the Primary and Secondary Chassis on page 50](#).
 - a. Verify that power is removed from both chassis.
 - b. Apply power to the chassis you want designated as the primary. Wait for the status indicator to display PRIM.
 - c. Apply power to the chassis you want designated as the secondary.

Install the Hardware

Follow these steps to configure and install the hardware components of your system.

Install the First Chassis

When you install a redundancy system, install one chassis, and its necessary components, at a time.

Module Placement and Partnering

Each pair of controllers and communication modules must be composed of compatible partner modules. Two modules in the same slot are considered as compatible partners only if they contain compatible hardware and firmware and other rules that the module can enforce. Either the module in the primary chassis or its partner in the secondary chassis determines the compatibility status (Compatible or Incompatible).

The redundancy module pair must occupy the same slots in their respective chassis. The redundancy module pair does not consider the chassis pair to be partnered if the redundancy modules are placed in different slots. This outcome is true even if the partners of other modules are present in the same slot.

The redundancy module prevents certain redundancy operations, such as Qualification, if incompatible modules reside in the redundant-control chassis pair.

IMPORTANT For best performance, place the redundancy module in the chassis as close as possible to the controller.

Complete these tasks to install the first chassis in the redundant chassis pair:

- [Install the Redundancy Module](#)



Do not apply power to the system until both chassis and their components are installed.

Then follow the steps that are described in [Update Redundant Firmware on page 48](#) to determine when to power each chassis.

Install the Redundancy Module

You must install one redundancy module in each chassis that is planned for your system. Available modules are as follows:

- 1756-RM2
- 1756-RM2XT
- 1756-RM/A
- 1756-RM/B
- 1756-RMXT

IMPORTANT Redundancy bundles version 24.052 and greater support only 1756-RM2 and 1756-RM2XT modules.

IMPORTANT 1756-RM2 or 1756-RM2XT modules can only be used with other 1756-RM2 or 1756-RM2XT modules. You cannot mix 1756-RM2 and 1756-RM2XT modules with 1756-RM/A, 1756-RM/B, or 1756-RMXT modules.

Installation Requirements

Before you install the module, be sure to note the following:

- Understand redundant systems and redundant media
- Verify that the planned modules for each redundant chassis of the pair are identical - including firmware revisions
- Verify that your redundancy firmware revision is compatible with your planned redundant chassis modules
- The 1756-RM/B module offers a higher level of performance than a 1756-RM/A module. Both modules can coexist in a redundant system, but the highest system performance is achieved when the 1756-RM/B modules are used together when used with a ControlLogix® 5570 controller.
- The 1756-RM2 module, when used with a ControlLogix 5570 controller, offers higher crossload speeds than the 1756-RM/B module.

Environment and Enclosure



ATTENTION: This equipment is intended for use in a Pollution Degree 2 industrial environment, in overvoltage Category II applications (as defined in IEC 60664-1), at altitudes up to 2000 m (6562 ft) without derating. This equipment is not intended for use in residential environments and may not provide adequate protection to radio communication services in such environments.

This equipment is supplied as open-type equipment. It must be mounted within an enclosure that is suitably designed for those specific environmental conditions that will be present and appropriately designed to prevent personal injury resulting from accessibility to live parts. The enclosure must have suitable flame-retardant properties to prevent or minimize the spread of flame, complying with a flame spread rating of 5VA or be approved for the application if nonmetallic. The interior of the enclosure must be accessible only by the use of a tool. Subsequent sections of this publication may contain additional information regarding specific enclosure type ratings that are required to comply with certain product safety certifications.

In addition to this publication, see the following:

- Industrial Automation Wiring and Grounding Guidelines, Rockwell Automation publication [1770-4.1](#), for additional installation requirements
- NEMA Standard 250 and IEC 60529, as applicable, for explanations of the degrees of protection provided by enclosure

Prevent Electrostatic Discharge



ATTENTION: This equipment is sensitive to electrostatic discharge, which can cause internal damage and affect normal operation. Follow these guidelines when you handle this equipment:

- Touch a grounded object to discharge potential static.
- Wear an approved grounding wrist strap.
- Do not touch connectors or pins on component boards.
- Do not touch circuit components inside the equipment.
- Use a static-safe workstation, if available.
- Store the equipment in appropriate static-safe packaging when not in use.

Removal and Insertion Under Power (RIUP)



WARNING: When you insert or remove the module while backplane power is on, an electrical arc can occur. This could cause an explosion in hazardous location installations.

Be sure that power is removed or the area is nonhazardous before proceeding. Repeated electrical arcing causes excessive wear to contacts on both the module and its mating connector. Worn contacts may create electrical resistance that can affect module operation.

European Hazardous Location Approval

The following applies when the product bears the Ex Marking.

This equipment is intended for use in potentially explosive atmospheres as defined by European Union Directive 94/9/EC and has been found to comply with the Essential Health and Safety Requirements relating to the design and construction of Category 3 equipment intended for use in Zone 2 potentially explosive atmospheres, given in Annex II to this Directive.

Compliance with the Essential Health and Safety Requirements has been assured by compliance with EN 60079-15 and EN 60079-0.



ATTENTION: This equipment is not resistant to sunlight or other sources of UV radiation.

**WARNING:**

- This equipment must be installed in an enclosure providing at least IP54 protection when applied in Zone 2 environments.
 - This equipment shall be used within its specified ratings defined by Rockwell Automation.
 - This equipment must be used only with ATEX certified Rockwell Automation backplanes.
 - Do not disconnect equipment unless power has been removed or the area is known to be nonhazardous.
-

Safety-related Programmable Electronic Systems



ATTENTION: Personnel responsible for the application of safety-related programmable electronic systems (PES) shall be aware of the safety requirements in the application of the system and shall be trained in using the system.

Optical Ports





ATTENTION: Under certain conditions, viewing the optical port may expose the eye to hazard. When viewed under some conditions, the optical port may expose the eye beyond the maximum permissible-exposure recommendations.

Small Form-factor Pluggable



WARNING: When you insert or remove the small form-factor pluggable (SFP) optical transceiver while power is on, an electrical arc can occur. This could cause an explosion in hazardous location installations. Be sure that power is removed or the area is nonhazardous before proceeding.

North American Hazardous Location Approval

The following information applies when operating this equipment in hazardous locations.	Informations sur l'utilisation de cet équipement en environnements dangereux.
<p>Products marked "CL I, DIV 2, GP A, B, C, D" are suitable for use in Class I Division 2 Groups A, B, C, D, Hazardous Locations and nonhazardous locations only. Each product is supplied with markings on the rating nameplate indicating the hazardous location temperature code. When combining products within a system, the most adverse temperature code (lowest "T" number) may be used to help determine the overall temperature code of the system. Combinations of equipment in your system are subject to investigation by the local Authority Having Jurisdiction at the time of installation.</p>	<p>Les produits marqués "CL I, DIV 2, GP A, B, C, D" ne conviennent qu'à une utilisation en environnements de Classe I Division 2 Groupes A, B, C, D dangereux et non dangereux. Chaque produit est livré avec des marquages sur sa plaque d'identification qui indiquent le code de température pour les environnements dangereux. Lorsque plusieurs produits sont combinés dans un système, le code de température le plus défavorable (code de température le plus faible) peut être utilisé pour déterminer le code de température global du système. Les combinaisons d'équipements dans le système sont sujettes à inspection par les autorités locales qualifiées au moment de l'installation.</p>
<div style="display: flex; align-items: center;">  <div> <p>AVERTISSEMENT : EXPLOSION HAZARD</p> <ul style="list-style-type: none"> • Do not disconnect equipment unless power has been removed or the area is known to be nonhazardous. • Do not disconnect connections to this equipment unless power has been removed or the area is known to be nonhazardous. Secure any external connections that mate to this equipment by using screws, sliding latches, threaded connectors, or other means provided with this product. • Substitution of components may impair suitability for Class I, Division 2. • If this product contains batteries, they must only be changed in an area known to be nonhazardous. </div> </div>	<div style="display: flex; align-items: center;">  <div> <p>AVERTISSEMENT : RISQUE D'EXPLOSION -</p> <ul style="list-style-type: none"> • Couper le courant ou s'assurer que l'environnement est classé non dangereux avant de débrancher l'équipement. • Couper le courant ou s'assurer que l'environnement est classé non dangereux avant de débrancher les connecteurs. Fixer tous les connecteurs externes reliés à cet équipement à l'aide de vis, loquets coulissants, connecteurs filetés ou autres moyens fournis avec ce produit. • La substitution de composants peut rendre cet équipement inadapté à une utilisation en environnement de Classe I, Division 2. • S'assurer que l'environnement est classé non dangereux avant de changer les piles. </div> </div>

Laser Radiation Ports



ATTENTION: Class 1 laser product. Laser radiation is present when the system is open and interlocks bypassed. Only trained and qualified personnel are allowed to install, replace, or service this equipment.

A redundant system is composed of two ControlLogix redundancy modules working together that supervise the operating states and state transitions that establish the basic framework for redundancy operations. The redundant pairs provide a bridge between chassis pairs that let other modules exchange control data and synchronize their operations. This illustration identifies the external features of the module.

Figure 11 - 1756-RM2 or 1756-RM2XT Modules

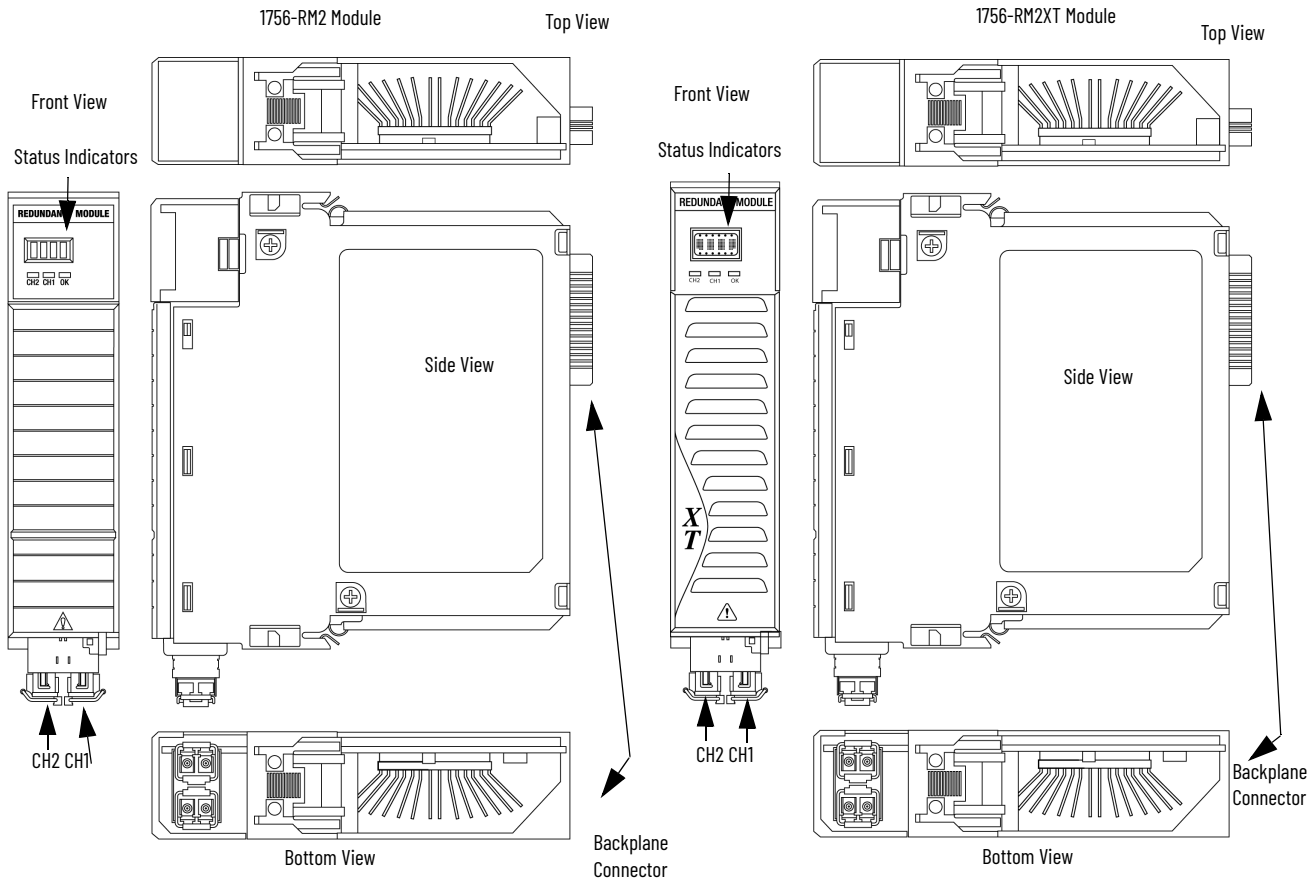

SFP transceivers are pre-installed in the redundant fiber ports

Figure 12 - 1756-RM/A or RM/B and 1756-RMXT Modules

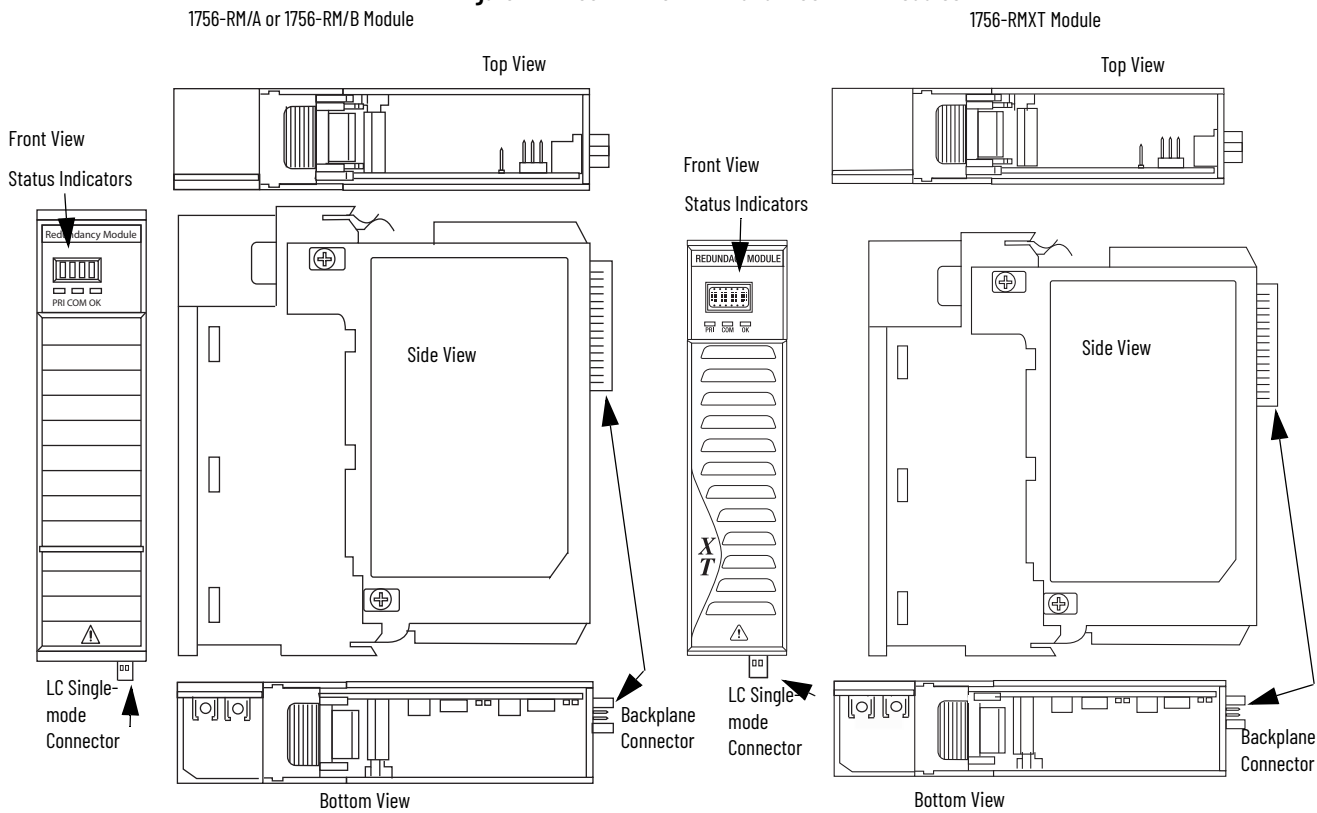

To install the redundancy module, follow these steps.

1. Align the circuit board with top and bottom guides in the chassis.
2. Slide the module into the chassis and make sure that the module backplane connector properly connects to the chassis backplane.

The module is properly installed when it is flush with other installed modules.

IMPORTANT To remove the module, push the locking clips at the top and bottom of each module and slide the module out of the chassis.

IMPORTANT If you are adding redundancy to an already operational ControlLogix system, shut off your process to install the redundancy module. The first chassis that you install the redundancy module into and turn on, becomes the primary chassis.

You can also have to do the following:

- Use RSNetWorx™ software to configure keeper information in the secondary ControlNet communication module if the master keeper for ControlNet communication is in the primary chassis
 - Enable redundancy in the programming software and remove any I/O modules from the chassis
-

The first chassis and its components are now installed. **Chassis power must remain off.**

Install the Second Chassis

Once the first chassis and its components are installed, you can install the second chassis of the redundant chassis pair.

See [Install the Redundancy Module on page 37](#) to install the second chassis.

IMPORTANT The components that are used in the first and second chassis must match exactly for the system to synchronize.

Connect the Redundancy Modules

Once the **first and second chassis and their components are installed**, you connect the redundancy modules via the 1756-RMCx fiber-optic communication cable. The cable is not included with the redundancy module. Before installation, order this fiber-optic communication cable separately.

Redundancy cables available from Rockwell Automation include the following.

Table 2 - Fiber-optic Cable Length

Fiber Cable Cat. No.	Length
1756-RMC1	1 m (3.28 ft)
1756-RMC3	3 m (9.84 ft)
1756-RMC10	10 m (32.81 ft)

IMPORTANT Longer cables can be user-made and are supported based on the optical power budget of the system. See [Fiber-optic Cable on page 46](#).

The cable connection is made at the bottom of the module in a downward orientation. There is enough space between the transmit and receive connectors so you can use the LC connector coupler. The use of this coupler keeps the fiber-optic cable from bending so you can connect and disconnect the cable without removing the module from the chassis.



ATTENTION: Consider these points when connecting the fiber-optic cable:

- The redundancy module communication cable contains optical fibers. Avoid making sharp bends in the cable. Install the cable in a location where it will not be cut, run over, abraded, or otherwise damaged.
- The redundancy module contains a single-mode transmitter. Connecting this module to a multi-mode port will damage any multi-mode devices.
- Media redundancy is achieved by installing modules with redundant ports and installing a redundant fiber cable system. If a cable failure occurs, or cable is degraded, the system uses the other cable.
- When using redundant media, route the two trunk cables (A and B) so that damage to one cable will not damage the other cable. This reduces the risk of both cables being damaged at the same time.
- Redundant cabling can tolerate one or more faults on a single channel. If a fault were to occur on both channels, the network operation would be unpredictable.



ATTENTION: Under certain conditions, viewing the optical port can expose the eye to hazard. When viewed under some conditions, the optical port can expose the eye beyond the maximum permissible exposure recommendations.

Connect the Fiber-optic Communication Cable to Redundant Channels

Follow this procedure to install the communication cable to redundant channels for the 1756-RM2 module.

IMPORTANT The redundancy module communication cable contains optical fibers. Avoid making sharp bends in the cable. Install the cable in a location where it is not cut, run over, abraded, or otherwise damaged.

1. Remove the protective plug on the first redundancy module in the redundant chassis pair.
2. Remove the protective caps from the cable.
3. Plug the cable connectors into the first redundancy module.
The ends must be inserted opposite each other.
4. If redundant fiber crossload cable is required, install the second fiber cable into the remaining port.
5. Plug the first end of the fiber cable into the CH1 port on the first chassis and plug the matching end into the matching CH1 port on the second chassis.

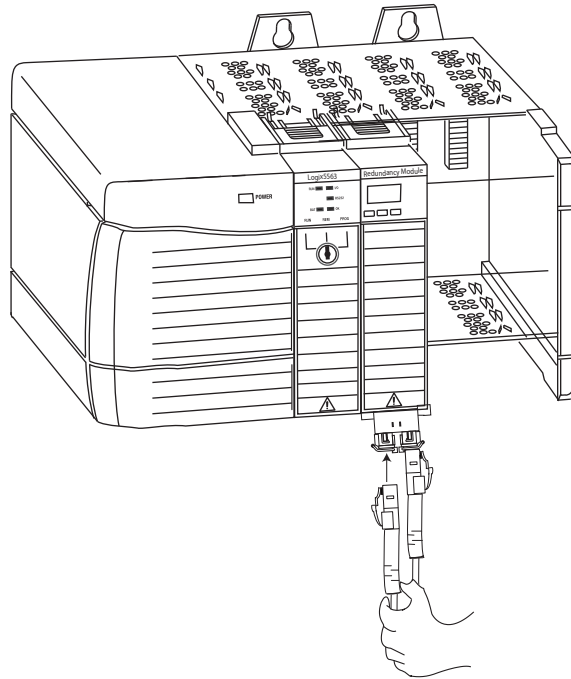

Connect the Fiber-optic Communication Cable to Single Channels

Follow this procedure to install the communication cable.

IMPORTANT The redundancy module communication cable contains optical fibers. Avoid making sharp bends in the cable. Install the cable in a location where it is not cut, run over, abraded, or otherwise damaged.

1. Remove the protective plug on the first redundancy module in the redundant chassis pair.
2. Remove the protective caps from the cable.
3. Plug the cable connector into the first redundancy module.
4. Plug the remaining cable-connector end to the second redundancy module.

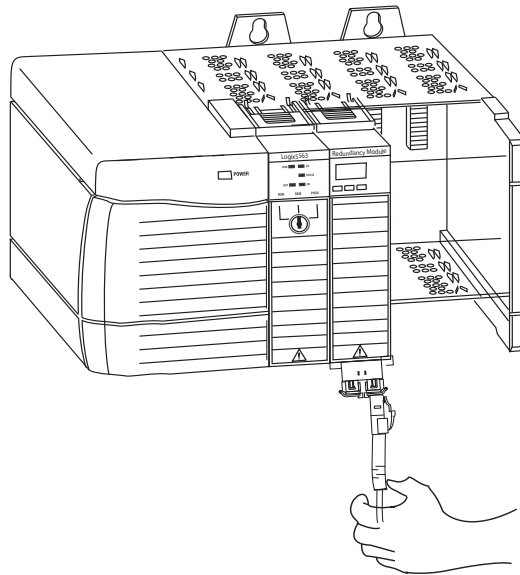

Fiber-optic Cable

If you choose to make your own fiber-optic cables, consider the following:

- Fiber-optic Communication Cable Specifications:

Attribute	1756-RM2	1756-RM2XT	1756-RM/A or 1756-RM/B	1756-RMXT
Temperature, operating	0...60 °C (32...140 °F)	-25...70 °C (-13...158 °F)	0...60 °C (32...140 °F)	-25...70 °C (-13...158 °F)
Connector type	LC-PC type (fiber-optic)			
Cable type	8.5/125 micron single-mode fiber-optic cable			
Channels	1 (transmit and receive fiber)			
Length, max	10 km (10,000 m, 10936.13 yd)		4 km (4000 m, 4,374.45 yd) ⁽¹⁾	
Transmission	1000 Mbps		Less than or equal to 100 Mbps	
Wavelength	1310 nm		1300 nm	
SFP transceiver	Transceiver Rockwell Automation PN-91972 Connector/cable: LC duplex connector, 1000BASE-LX-compliant		-	

(1) Longer distances are supported based on the optical power budget of the system. See the [Optical Power Budget Ranges for 1756-RM2 and 1756-RM2XT Modules on page 46](#).

- Determine Optical Power Budget

You can determine the maximum optical-power budget in decibels (dB) for a fiber-optic link by computing the difference between the minimum transmitter-output optical power (dBm avg) and the lowest receiver sensitivity (dBm avg). As shown in [Table 3](#), the maximum optical power budget for the 1756-RM2 module is -9.5 - (-19) or 9.5 dBm.

The optical-power budget provides the necessary optical-signal range to establish a working fiber-optic link. You must account for the cable lengths and the corresponding link penalties. All penalties that affect the link performance must be accounted for within the link optical power budget.

Table 3 - Optical Power Budget Ranges for 1756-RM2 and 1756-RM2XT Modules

Transmitter	Min	Typical	Max	Unit
Output optical power	-9.5	-	-3	dBm
Wavelength	1270	-	1355	nm
Receiver	Min	Typical	Max	Unit
Receiver sensitivity	-	-	-19	dBm
Receiver overload	-	-	-3	dBm
Input operating wavelength	1270	-	1355	nm

Use Dual Fiber Ports with the 1756-RM2 Redundancy Module

The dual fiber ports of the 1756-RM2 module constitute a redundant pair of communication channels between the partner 1756-RM2 modules in a redundant chassis pair. One of the channels is termed as 'ACTIVE', while the other channel is termed as 'REDUNDANT'. All data communication between the partner redundancy modules is conducted exclusively over the ACTIVE channel. If or when the ACTIVE channel fails, a 'Fiber Channel Switchover' is initiated automatically and all data communication shifts to the REDUNDANT channel, which then becomes the new ACTIVE channel.

Fiber Channel Switchover

Due to the fiber channel switchover, the redundant chassis pair remains synchronized even after a failure of the ACTIVE channel. Any of the following failures of the ACTIVE channel trigger an automatic fiber channel switchover to the REDUNDANT channel, provided the REDUNDANT channel is still operating in a normal condition:

- Signal attenuation along the fiber cable path that is routed between the partner redundancy modules
- A broken or damaged fiber cable that is routed between the partner redundancy modules
- Improper or loosely fit cable connector
- SFP transceiver fault
- Removal or loose connection of the SFP transceiver
- Data communication error (signaled by a failed CRC check)

Chassis synchronization is lost only when both of the channels have failed or are disconnected.

The fiber channel switchover can occasionally extend the completion of data communication packets between the partner redundancy modules. Therefore, the scan time of the controller can occasionally experience a delay of 10 ms or less.

Configuration

The use of dual fiber ports is entirely 'plug and play'. There is no user configuration that is needed for any of the operations of the active and redundant channels. The firmware automatically manages the selection of active and redundant channels. The dual fiber cables between the partner redundancy modules can be crossed over between CH1 and CH2 without any restriction.

Monitoring and Repair

Synchronization is preserved if the REDUNDANT channel has failed or is being repaired. The repair of the REDUNDANT channel can be performed online while the redundant chassis pair is running synchronized. To aid online repairs, the fiber cable connections and SFP transceiver can be removed and inserted under power.

It is not mandatory to have the REDUNDANT channel that is connected between the two redundancy modules. The redundant chassis pair can be synchronized with just one of the channels connected. The REDUNDANT channel can be installed later while the chassis is running synchronized.

The status indicators on the front panel and the indicators and counters that are displayed in the RMCT provide monitoring of the channel status.

Update Redundant Firmware

Use ControlFLASH or ControlFLASH Plus software to upgrade the firmware of each module in each chassis.

IMPORTANT Apply power **ONLY** to the chassis that contains modules on which you are upgrading firmware.

IMPORTANT Redundancy module firmware that is contained in the redundancy system firmware bundle is designed for use with the 1756-RM, 1756-RM2, 1756-RMXT, and 1756-RM2XT redundancy modules.

Upgrade the Firmware in the First Chassis

Complete these steps to upgrade the firmware in the first chassis.

1. Apply power to the chassis.

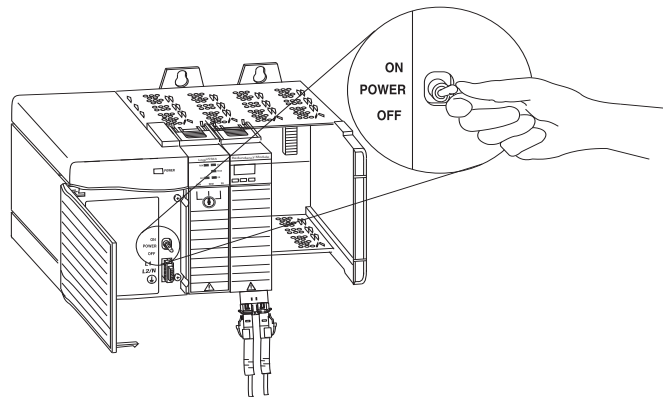

2. Set the mode switch on the controller to REM.

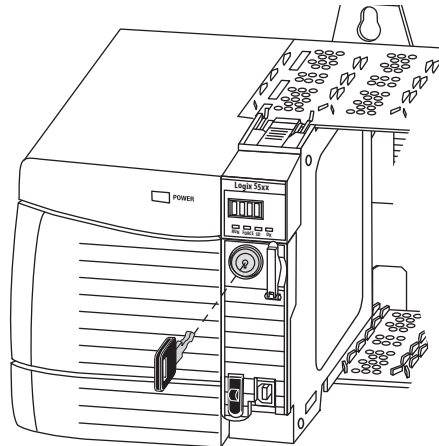

- Wait for the redundancy module to complete its start-up scroll messages. Check the module's status indicators. Wait 45 seconds before you begin updating the 1756-RM/1756-RM2 firmware. During this time, the redundancy module conducts internal operations to prepare for an update.

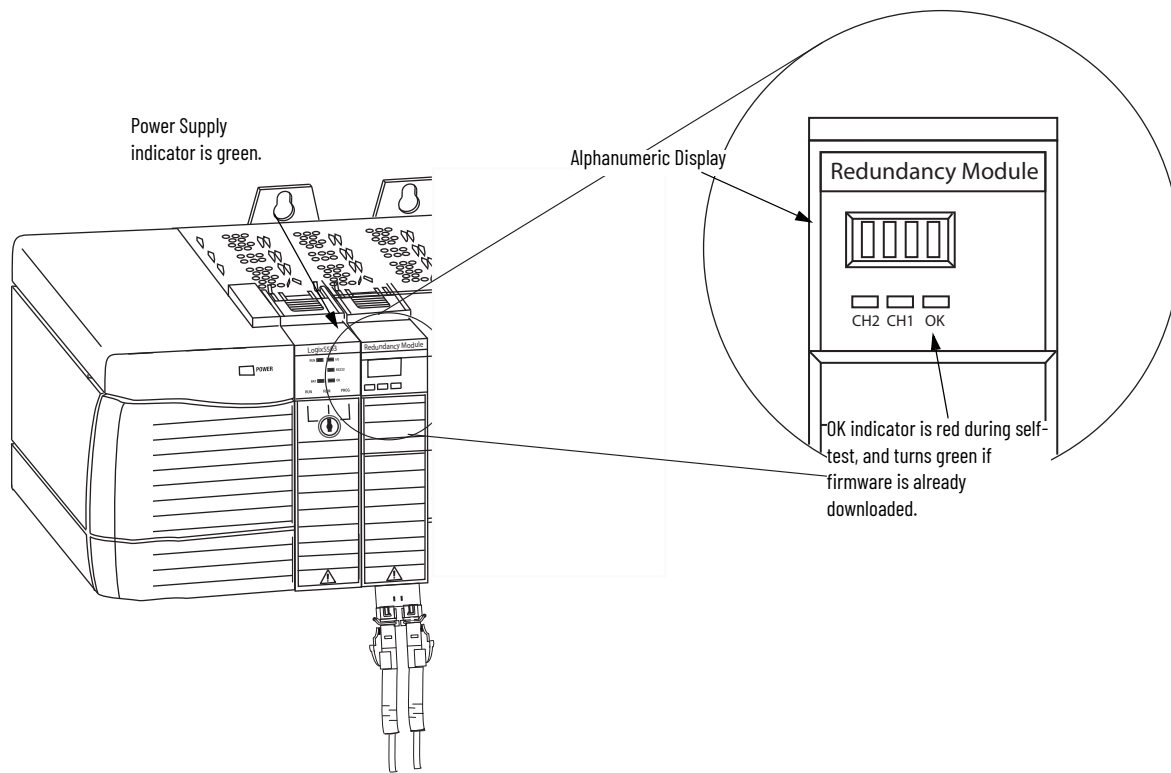

If it is a new module, wait until APPLICATION UPDATE REQUIRED is displayed. The status indicator flashes red.

- Launch ControlFLASH or ControlFLASH Plus software and click Next to begin the update process.
- Select the catalog number of the module (upgrade the redundancy module first) and click Next.

IMPORTANT The 1756-RM2 module uses different firmware than the 1756-RM and 1756-RMXT modules.

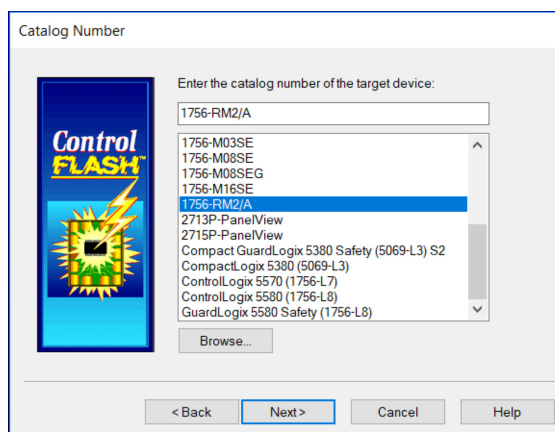

- Expand the network driver to locate the redundancy module or module you are upgrading.

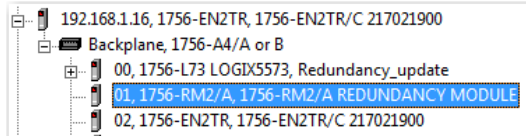

- Select the module and click OK.
- Select the firmware revision that you want to update to and click Next.
- Click Finish.
- On the confirmation dialog box that appears click Yes.

IMPORTANT This process can take a few minutes. The system can look like it is not doing anything, but it is. When the update is complete, the Update Status dialog box appears and indicates that the update has successfully completed.

Status: Update complete. Please verify this new firmware update before using the target device in its intended application.

- Click OK.
- Verify that the redundancy module status displays PRIM, which indicates a successful upgrade.
- Complete steps [4...12](#) for each module in the chassis.

IMPORTANT Power off the first chassis after you have verified a successful update of each module.

Upgrade the Firmware in the Second Chassis

Complete these steps to update the firmware for the modules in the second chassis.

- Apply power to the second chassis.
- Complete steps [3...12](#) in section [Upgrade the Firmware in the First Chassis](#) beginning on [page 48](#) for the modules in the second chassis.
- Power off the second chassis after you have verified the successful upgrade of each module.

Designate the Primary and Secondary Chassis

Power on the chassis you want to designate as the primary chassis first. After you have applied power, qualify the system so that all module pairs are at compatible firmware revision levels.

IMPORTANT Do not apply power to the chassis until you have read the instructions for designating the primary chassis. Applying power to the chassis in the correct order is crucial to designating the primary and secondary chassis. Do not attempt to designate a primary chassis before loading in an application image. Before you designate the primary chassis and qualify the system, make sure that you have the latest firmware installed. See [Update Redundant Firmware on page 48](#).

Complete these steps to designate the primary and secondary chassis of a redundant pair.

1. Verify that power is removed from both chassis.
2. Apply power to the chassis you want to designate as the primary chassis and wait for the status indicators of the module to display **PRIM**.
3. Apply power to the chassis you want to designate as the secondary chassis.
4. Verify primary and secondary chassis designations by viewing the module status display and the PRI indicator.

See [Redundancy Module Status Indicators on page 178](#) for specific redundancy module display information.

IMPORTANT If both modules have power applied to them simultaneously, the module with the lowest IP address is designated as the primary chassis and displays PRIM on the four-character display of the module. In addition, the PRI status indicator on the primary redundancy module is green. The secondary chassis displays either DISQ or SYNC, depending on the state of the secondary chassis. In addition, the PRI status light on the secondary redundancy module is not illuminated.

After Designation

When you first apply power to the designated primary and secondary chassis, compatibility checks are carried-out between the redundant chassis. Then, if the Auto-Synchronization parameter is set at Conditional, qualification begins.



While the qualification occurs, the module status display transitions from DISQ (disqualified) to QFNG (qualifying) to SYNC (synchronized). The qualification is complete in 1...3 minutes and then module status display indicates the qualification status.

Use this table as a reference when interpreting the qualification status of the modules that are displayed on the module status display.

Module Status Display	Interpretation
QFNG	Qualification processes are in progress.
SYNC	SYNC displays after qualification processes are complete. This indicates that chassis configuration and the firmware revision levels are compatible and that the secondary chassis is ready to assume control if there is a major fault in the primary chassis.
DISQ...QFNG...DISQ	If DISQ continues to display after about 3 minutes, one of these anomalies exists: <ul style="list-style-type: none"> • Incorrect chassis configuration. That is, incompatible hardware is used. • Incompatible firmware revisions are used between the primary and secondary modules. • Keeper parameters between ControlNet module partners are not the same. • The partnered ControlNet modules are not set to the same node address. • The partnered EtherNet/IP modules are not set to the same IP Configuration. • The Auto-Synchronization parameter within the Redundancy Module Configuration Tool is set to Never or Conditional (default setting).

Conversion from a Non-redundant to a Redundant System

To upgrade the standalone chassis to a redundant chassis pair:

1. Insert a redundancy module in a spare slot in the standalone chassis, and
2. Configure an identical chassis with compatible modules in the same slot as the standalone chassis (including the redundancy module).

A partnered chassis that is designated as the secondary chassis stops functioning if it contains:

- non-redundancy-compliant modules;
- or, modules not compatible with Enhanced redundancy;
- or, non-redundancy-compliant firmware

For more information, see [Convert from a Non-redundant System on page 185](#).

Qualification Status Via the RMCT

To view the qualification attempt, access the Synchronization or Synchronization Status tabs of the RMCT. These tabs provide information about qualification attempts and redundant chassis compatibility.

For more information on how to use the RMCT, see [Chapter 6, Configure the Redundancy Modules on page 75](#).

Figure 13 - RMCT Synchronization Status Tab

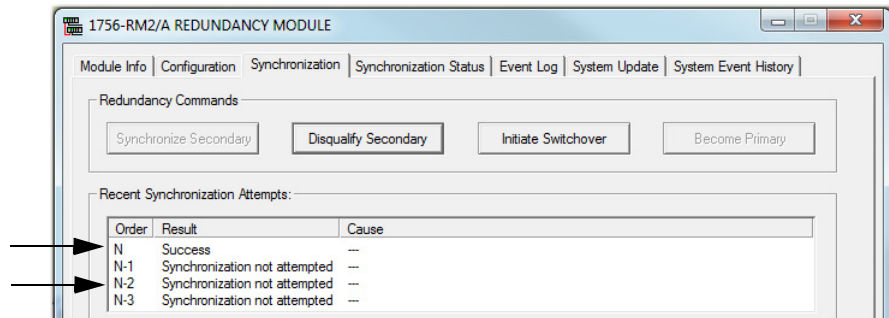
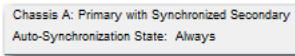

Figure 14 - Synchronization Status Tab for Chassis Compatibility



In addition, you can view events specific to qualification in the Event Log of the RMCT.

Figure 15 - Event Log with Qualification Events

Event	Log Time	Slot	Module Na...	Description	Classification
3407	12/16/2015 15:21:30:118	1	1756-RM2	(32) Autoqual. State Change	Configuration
3406	12/16/2015 15:21:30:117	1	1756-RM2	(F) Autoqual. Option Set to 'Always'	Configuration
3405	12/16/2015 15:05:47:592	1	1756-RM2	(1A) Chassis Redundancy State changed ...	State Changes
3404	12/16/2015 15:05:47:461	2	1756-EN2TR	(14) Enter Qualification Phase 4	Qualification
3403	12/16/2015 15:05:47:434	1	1756-RM2	(2E) Qualification Complete	Qualification
3402	12/16/2015 15:05:47:421	2	1756-EN2TR	(13) Enter Qualification Phase 3	Qualification
3401	12/16/2015 15:05:46:426	2	1756-EN2TR	(12) Enter Qualification Phase 2	Qualification
3400	12/16/2015 15:05:44:670	2	1756-FN2TR	(11) Enter Qualification Phase 1	Qualification

Reset the Redundancy Module

There are two ways to reset the module.

- Cycle power to the chassis.
- Remove the module from the chassis and reinsert the module.

IMPORTANT Do not choose to cycle power to the chassis if it causes you to lose control of your process.

Remove or Replace the Redundancy Module

To remove or replace the redundancy module, follow these steps.

1. To disengage the upper and lower module tabs, push them.
2. Slide the module out of the chassis.
3. Insert the replacement in the same slot and move the fiber cable(s) to the new module.

IMPORTANT If you want to resume system operation with an identical module, you must install the new module in the same slot.

Notes:

Configure the EtherNet/IP Network

Topic	Page
Requested Packet Interval	55
IP Address Swapping	56
CIP Sync	58
Produce/Consume Connections	61
Configure EtherNet/IP Communication Modules in a Redundant System	63
Use a Redundancy System with Device Level Ring	64
Use a Redundancy System with Parallel Redundancy Protocol	64

Requested Packet Interval

When using revisions earlier than 20.054, the RPI for I/O connections in a redundancy-enabled controller tree must be less than or equal to 375 ms. When using revision 20.054 or later, the RPI can be the same as a non-redundant chassis.

CPU Usage

[Table 4](#) describes CPU usage for EtherNet/IP™ communication modules.

Table 4 - System Resource Utilization Table

If the CPU utilization rate is	Then
0...80%	No action is required. Important: This range is the optimal rate.
Greater than 80%	<ul style="list-style-type: none"> Take steps to reduce your CPU utilization. See the EtherNet/IP Network Configuration User Manual, publication ENET-UM001. Adjust the requested packet interval (RPI) of your connection. Reduce the number of devices that are connected to your module. Important: Your EtherNet/IP communication module can function at 100% CPU capacity, but at or near this rate, you run the risk of CPU saturation and performance problems.

IP Address Swapping

IP address swapping is a feature available to EtherNet/IP communication modules in a redundancy system where a partnered set of EtherNet/IP communication modules swap IP addresses during a switchover.

IMPORTANT You must use IP address swapping to use remote I/O and produce/consume connections of an EtherNet/IP network.

Determine Use of IP Address Swapping

Depending on your EtherNet/IP network configuration, you can choose to use IP address swapping between your partnered EtherNet/IP communication modules in the event of a switchover.

If you want to	Then
Minimize data server communication recovery time during switchover ⁽¹⁾	Do not use IP address swapping
Have your partnered EtherNet/IP communication modules on different subnets	
Use Remote I/O or produce/consume.	Use IP address swapping
Have your partnered EtherNet/IP communication modules on the same subnet	

(1) For more information, see [Data Server Communication Recovery Time Reduction During a Switchover on page 15](#).

If you are using different subnets, you are responsible for programming your system to use the address and subnet of the new primary chassis in the event of a switchover.

Do Not Use IP Address Swapping

If you do not use IP address swapping, assign unique values for these configuration parameters **at minimum** on both EtherNet/IP communication modules in the partnered set:

- IP address

IMPORTANT The IP address **cannot** be of the following format between the partner EtherNet modules: aaa.bbb.ccc.ddd & aaa.bbb.ccc.(ddd+1)

Use IP Address Swapping

If you use IP address swapping, assign the same values for these configuration parameters on both EtherNet/IP communication modules in the partnered set:

- IP address
- Subnet mask
- Gateway address

[Figure 16](#) shows a partnered set of EtherNet/IP communication modules during initial configuration.

Figure 16 - IP Addresses of EtherNet/IP Communication Modules During System Configuration

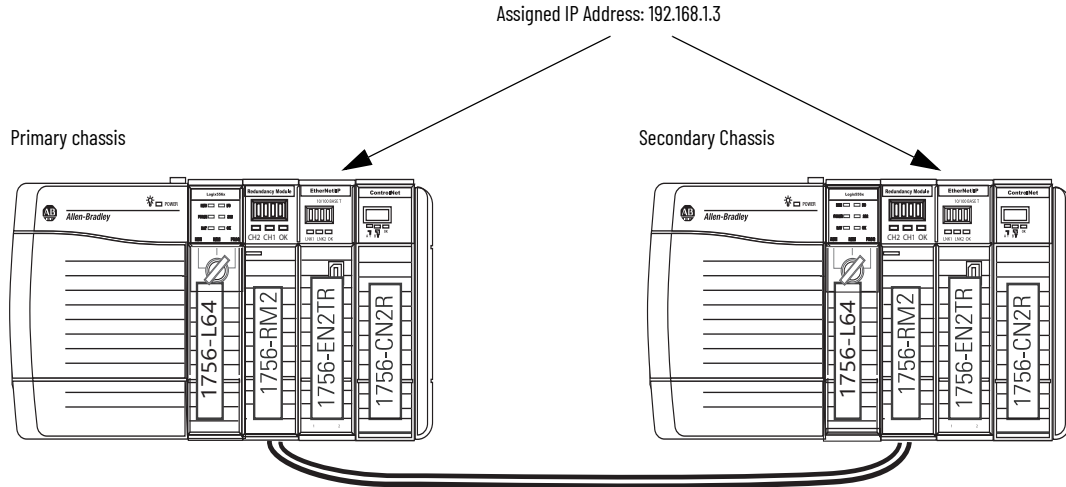

When a redundancy system begins operating, the primary EtherNet/IP communication module uses the IP address that is assigned during initial configuration. The secondary EtherNet/IP communication module automatically changes its IP address to the next highest value. When a switchover occurs, the EtherNet/IP communication modules swap IP addresses.

For example, if you assign IP address 192.168.1.3 to both EtherNet/IP communication modules in a partnered set, on initial system operation, the secondary EtherNet/IP communication module automatically changes its IP address to 192.168.1.4.

[Figure 17](#) shows a partnered set of EtherNet/IP communication modules after system operation begins.

Figure 17 - IP Addresses of EtherNet/IP Communication Modules After System Operation Begins

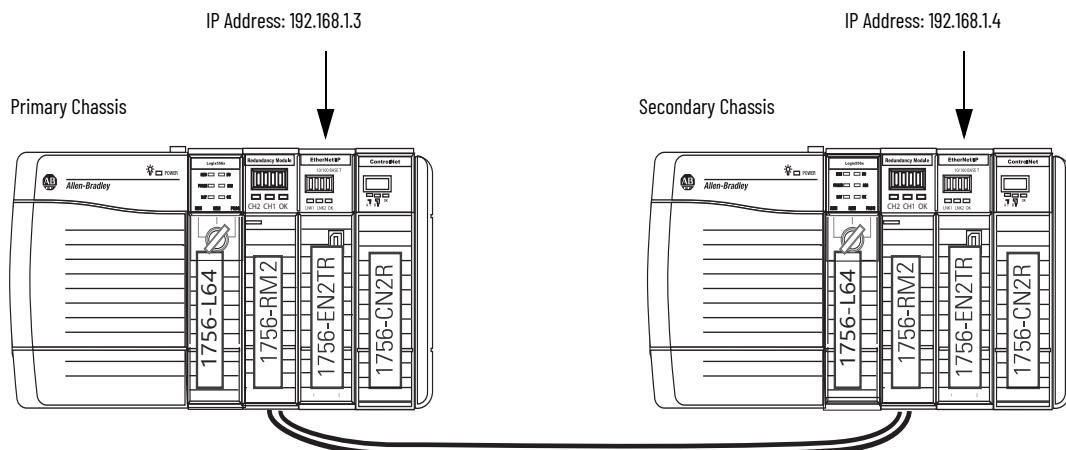

Do not assign IP addresses to EtherNet/IP communication modules outside the partnered set to values that conflict with those values that are used in the partnered set.

In the previous example, the partnered set uses 192.168.1.3 and 192.168.1.4. Use 192.168.1.5 or higher for all EtherNet/IP communication modules outside the partnered set.

[Figure 18](#) shows the partnered set of EtherNet/IP communication modules in the communication software after system operation begins.

Figure 18 - IP Addresses in Communication Software

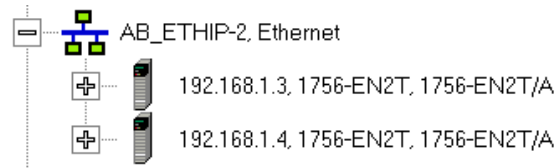

Static Versus Dynamic IP Addresses

We recommend that you use static IP addresses on EtherNet/IP communication modules in redundancy systems.



ATTENTION: If you use dynamic IP addresses and a power outage, or other network failure occurs, modules that use dynamic IP addresses can be assigned new addresses when the failure is resolved. If the IP addresses change, your application could experience a loss of control or other serious complications with your system.

You cannot use dynamic IP addresses with IP address swapping.

Reset the IP Address for an EtherNet/IP Communication Module

If necessary, you can reset the IP address of a 1756-EN2x communication module to the factory default value. To return to the factory default, set the rotary switches on the module to 888 and cycle power.

After you cycle power to the EtherNet/IP communication module, you can either set the switches on the module to the desired address, or set the switches to 999 and use one of these methods to set the IP address:

- BOOTP-DHCP server
- Communication software
- Programming software

CIP Sync

With redundancy system revision 19.052 or greater, you can use CIP Sync™ technology. CIP Sync technology provides a mechanism to synchronize clocks between controllers, I/O devices, and other automation products in your architecture with minimal user intervention.

CIP Sync technology uses Precision Time Protocol (PTP) to establish a Master/Slave relationship among the clocks for each CIP Sync-enabled component in the system. One master clock, which is known as the Grandmaster, sets the clock to which all other devices on the network synchronize their clocks.

IMPORTANT Before you use this enhancement in a redundancy system, revision 19.052 or later, see these publications for a full understanding of CIP Sync technology in any system:

- Integrated Architecture™ and CIP Sync Configuration Application Technique, publication [IA-AT003](#)
- ControlLogix® System User Manual, publication [1756-UM001](#)

Consider these points when you use CIP Sync technology in a redundancy system, revision 19.052 or later:

- If you enable CIP Sync Time Synchronization in the controllers in a redundant chassis pair, you must also enable Time Synchronization in the EtherNet/IP communication modules in the redundant chassis pair so all devices have one path to the Grandmaster. To enable Time Synchronization in the EtherNet/IP communication modules, change the Time Sync Connection from None (default) to Time Sync and Motion.

If time synchronization is enabled in any controller in the primary chassis of a disqualified redundant chassis pair, and no other devices in the primary chassis have time synchronization enabled, the redundant chassis pair attempts to qualify. However, in these application conditions, the attempt to qualify fails.

- While CIP Sync technology can handle multiple paths between master and slave clocks, it resolves mastership most effectively if you configure the redundant paths so that Time Synchronization is enabled in only the minimum required number of EtherNet/IP communication modules.

For example, if your redundant chassis pair has three 1756-EN2T communication modules and all are connected to the same network, enable Time Synchronization in only one of the modules.

- If the primary controller is the Grandmaster, the redundancy system automatically manages the CIP Sync clock attributes so that the controller in the primary chassis is always set to be the Grandmaster instead of the secondary controller. This clock management makes sure of a change to a new Grandmaster when the redundancy system switches over.
- When a switchover occurs, these events take place:
 - The Grandmaster status transfers from the original primary controller to the new primary controller. This transfer can take longer to complete than if Grandmaster status was transferred between devices in a non-redundant system.
 - After the switchover is complete, system synchronization can take longer in a redundancy system, revision 19.052 or later, which uses CIP™ technology than one that does not.
- If you attempt to use the Redundant System Update (RSU) feature to update a redundancy system, revision 16.081 or earlier, which uses Coordinated System Time (CST), the redundancy system, revision 19.052 or later, does not permit a locked switchover and the update fails to complete.

To work around this restriction, first disable CST Mastership in the original redundancy system and then use RSU to update the redundancy system to revision 19.052 or later.

[Figure 19 on page 60](#) shows an example redundancy system, revision 19.052 or later, that uses CIP Sync technology.

Figure 19 - Redundancy System, Revision 19.052 or greater, Using CIP Sync Technology

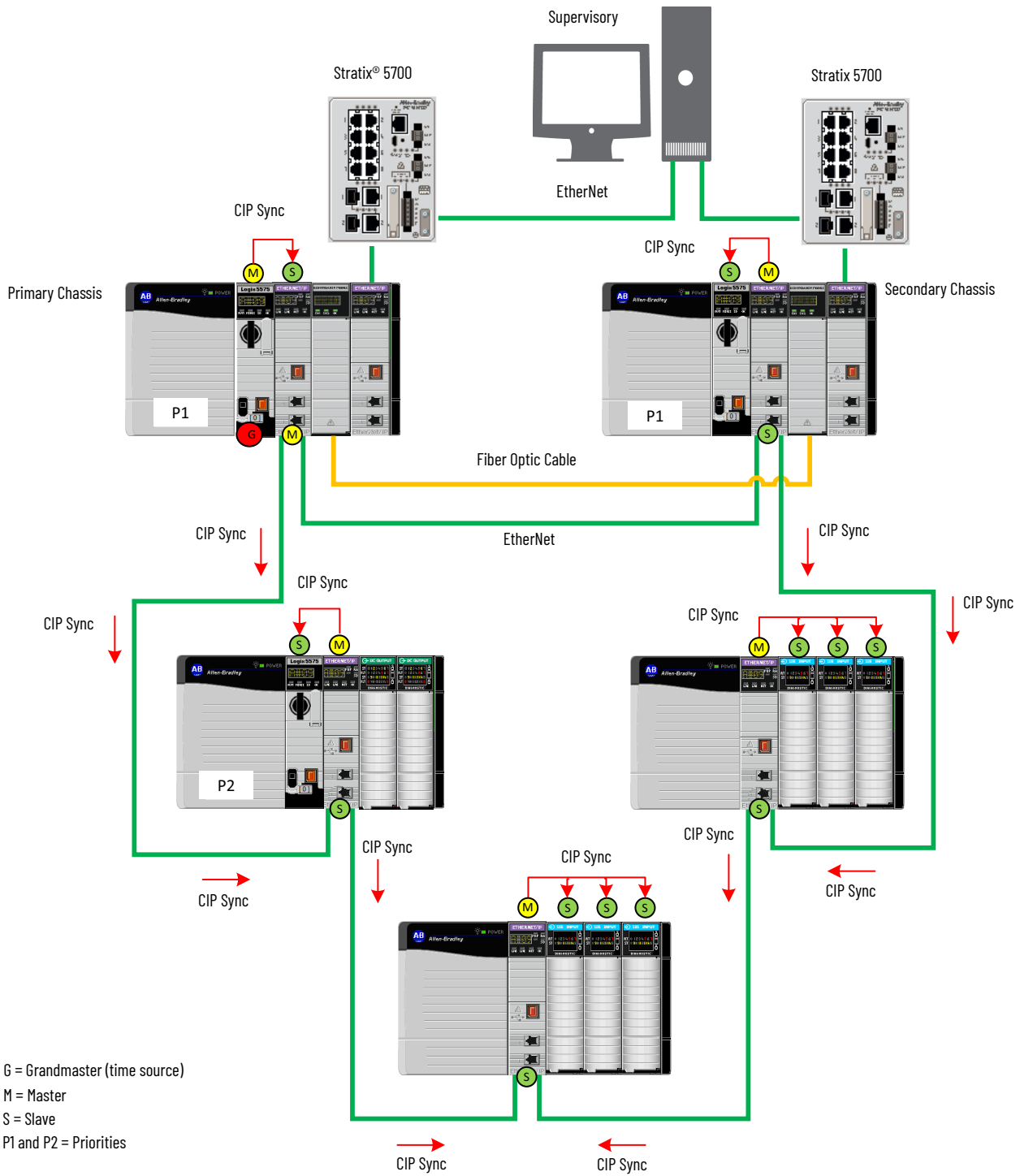

Produce/Consume Connections

With redundancy system revision 19.052 or later, you can use produce/consume connections over an EtherNet/IP network. Controllers let you produce (broadcast) and consume (receive) system-shared tags.

IMPORTANT Sockets are supported in the 1756-EN2T, 1756-EN2TR and 1756-EN2F modules, firmware revision 5.008 or later. For additional information, see the EtherNet/IP Socket Interface Application Technique, publication [ENET-AT002](#).

IMPORTANT Unicast functionality in redundancy systems supports produced tags. Unicast consumed tags are not supported.



When using ControlLogix 5570 controllers in your system, you must use revision 19.053 or greater.

Figure 20 - Example System Using Produced and Consumed Tags

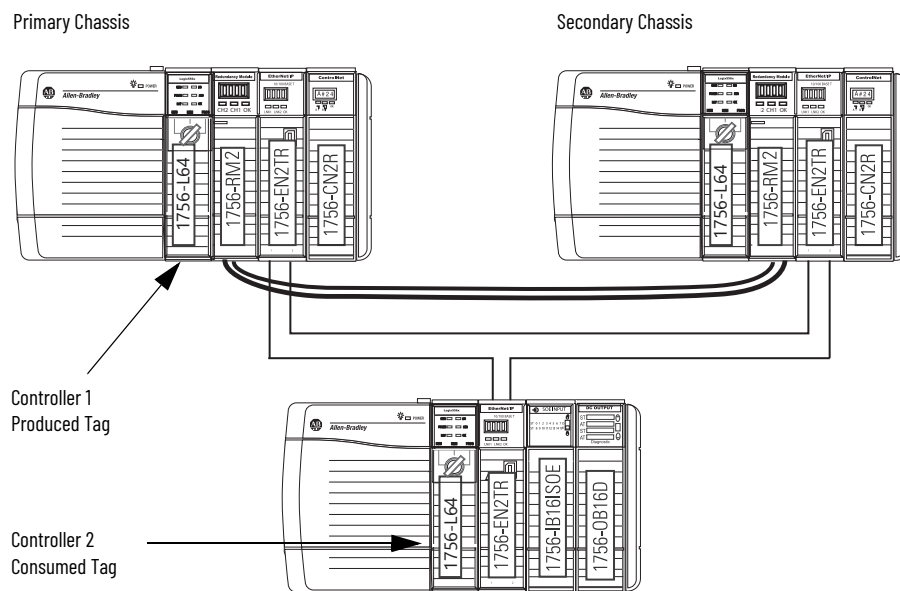

These requirements exist when you use produced and consumed connections over an EtherNet/IP network in a redundancy system, revision **19.052** or greater:

- You cannot bridge produced and consumed tags over two networks. For two controllers to share produced or consumed tags, both must be attached to the same network.
- Produced and consumed tags use connections in both the controllers and the communication modules being used.
- Because the use of produced and consumed tags uses connections, the number of connections available for other tasks, such as the exchange of I/O data, is reduced.

The number of connections available in a system depends on controller type and network communication modules used. Closely track the number of produced and consumed connections to leave as many as necessary for other system tasks.

- Produced and consumed tags must be configured in both the producing controller and the consuming controller. Produced tags in a redundant ControlLogix controller can be configured as either multicast or unicast. Consumed tags by a redundant ControlLogix controller must be configured as multicast in the producing controller.

- When you add an Ethernet module for the redundancy chassis to the I/O tree of a remote consuming controller, change the Connection setting from Rack Optimized to None. If this setting is not changed the configured connection can briefly drop during a switchover.

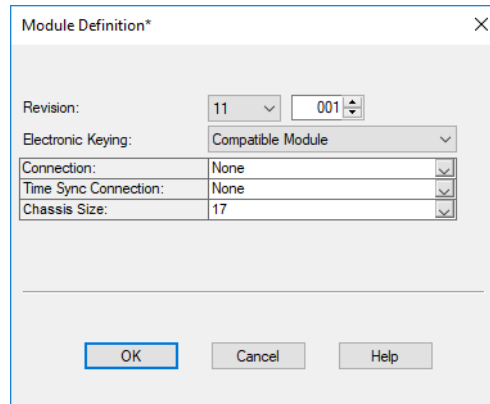

Produced/Consumed Tags between Primary Controllers and Non-redundant Controllers

The connection from the remote controller to the redundant controller can briefly drop during a switchover. This condition can occur if the EtherNet/IP communication modules of the remote chassis do not use specific firmware revisions. The controllers in the redundant chassis pair must also produce tags over the EtherNet/IP network that the controllers in the remote chassis consume.

Use these firmware revisions for EtherNet/IP communication modules in the remote chassis to maintain connections during a switchover.

Table 5 - Minimum Firmware Revision for Communication Modules in Remote Chassis

Communication Module in Remote Chassis	Minimum Firmware Revision
1756-EN2F	5.008 (unsigned) 5.028 (signed)
1756-EN2T	4.002
1756-EN2TR	
1756-EN3TR	
1756-EN4TR	
1756-ENBT	6.001
1768-ENBT	4.001
1769-L2x	19.011
1769-L3xE	
1788-ENBT	3.001
CompactLogix 5380 controllers	28.011
ControlLogix 5580 controllers	
CompactLogix 5480 controllers	32.012

IMPORTANT The minimum firmware revisions that are listed in [Table 5](#) apply only to EtherNet/IP communication modules in the remote chassis. In a redundant chassis pair, you can use only the ControlLogix modules that are listed in the respective bundle's release notes

Configure EtherNet/IP Communication Modules in a Redundant System

Use these procedures to configure EtherNet/IP communication modules that are used in redundant chassis.

Before You Begin

Before you begin configuring the EtherNet/IP communication modules in the redundant chassis, verify that these tasks have been completed:

- The redundancy modules are installed and connected in the redundant chassis.
- A plan for IP address use has been executed:
 - If you are using IP address swapping, plan for the use of two consecutive IP addresses in the partnered set.
 - If you are not using IP address swapping, plan for the use of two IP addresses.
- Know the subnet mask and gateway address for the Ethernet network the redundant modules are to operate on.

Options for Setting the IP Addresses of EtherNet/IP Communication Modules

By default, ControlLogix EtherNet/IP communication modules ship with the IP address set to 999 and with Bootstrap Protocol (BOOTP)/Dynamic Host Configuration Protocol (DHCP)-enabled.

Use one of these tools to set the IP addresses for your EtherNet/IP communication modules:

- Rotary switches on the module
- Communication software
- Programming software
- BOOTP/DHCP utility

Half/Full Duplex Settings

The redundancy system uses the duplex settings of the EtherNet/IP communication module that is the primary. After a switchover, the duplex settings of the new primary EtherNet/IP communication module are used. By default, the duplex setting is automatic. We recommend that you use this setting whenever possible.

To avoid communication errors, configure both the primary and secondary EtherNet/IP communication modules with the same duplex settings. If you use different duplex settings on partnered EtherNet/IP communication modules, then messaging errors can occur after a switchover.

Use a Redundancy System with Device Level Ring

Device Level Ring (DLR) is an EtherNet/IP protocol defined by ODVA, Inc. DLR provides a means for detecting, managing, and recovering from single faults in a ring-based network.

A DLR network includes the following types of ring nodes.

Node	Description
Ring supervisor	<p>A ring supervisor provides these functions:</p> <ul style="list-style-type: none"> • Manages traffic on the DLR network • Collects diagnostic information for the network <p>A DLR network requires at least one node to be configured as ring supervisor.</p> <p>IMPORTANT: By default, the supervisor function is disabled on supervisor-capable devices, so they are ready to participate on a linear or star network or as a ring node on a DLR network.</p> <p>In a DLR network, you must configure at least one of the supervisor-capable devices as the ring supervisor before physically connecting the ring. If you do not, the DLR network does not work.</p> <p>IMPORTANT: We recommend to assign at least one supervisor outside of the redundant chassis pair to prevent losing supervision of the DLR during switchover.</p> <p>For more information on DLR operation see the EtherNet/IP Device Level Ring Application Technique, publication ENET-AT007.</p>
Ring participants	<p>Ring participants provide these functions:</p> <ul style="list-style-type: none"> • Process data that is transmitted over the network. • Pass on the data to the next node on the network. • Report fault locations to the active ring supervisor. <p>When a fault occurs on the DLR network, ring participants reconfigure themselves and relearn the network topology.</p>
Redundant gateways (optional)	<p>Redundant gateways are multiple switches connected to a single DLR network and also connected together through the rest of the network.</p> <p>Redundant gateways provide DLR network resiliency to the rest of the network.</p>

Depending on their firmware capabilities, both devices and switches can operate as supervisors or ring nodes on a DLR network. Only switches can operate as redundant gateways.

For more information about DLR, see the EtherNet/IP Device Level Ring Application Technique, publication [ENET-AT007](#).

Use a Redundancy System with Parallel Redundancy Protocol

Parallel Redundancy Protocol (PRP) is defined in international standard IEC 62439-3 and provides high-availability in Ethernet networks. PRP technology creates seamless redundancy by sending duplicate frames to two independent network infrastructures, which are known as LAN A and LAN B.

A PRP network includes the following components.

Component	Description
LAN A and LAN B	Redundant, active Ethernet networks that operate in parallel.
Double attached node (DAN)	An end device with PRP technology that connects to both LAN A and LAN B.
Single attached node (SAN)	An end device without PRP technology that connects to either LAN A or LAN B. A SAN does not have PRP redundancy.
Redundancy box (RedBox)	A switch with PRP technology that connects devices without PRP technology to both LAN A and LAN B.
Virtual double attached node (VDAN)	An end device without PRP technology that connects to both LAN A and LAN B through a RedBox. A VDAN has PRP redundancy and appears to other nodes in the network as a DAN.
Infrastructure switch	A switch that connects to either LAN A or LAN B and is not configured as a RedBox.

For more information about PRP topologies and configuration guidelines, see the EtherNet/IP Parallel Redundancy Protocol Application Technique, publication [ENET-AT006](#).

Configure the ControlNet Network

Topic	Page
Produce/Consume Connections	65
Network Update Time	66
Scheduled or Unscheduled Network	68
Schedule a New Network	69
Update an Existing Scheduled Network	71
Check the Network Keeper States	73

Produce/Consume Connections

You can use produce/consume connections over a ControlNet® network. Controllers let you produce (broadcast) and consume (receive) system-shared tags.

Figure 21 - Example System Using Produced and Consumed Tags

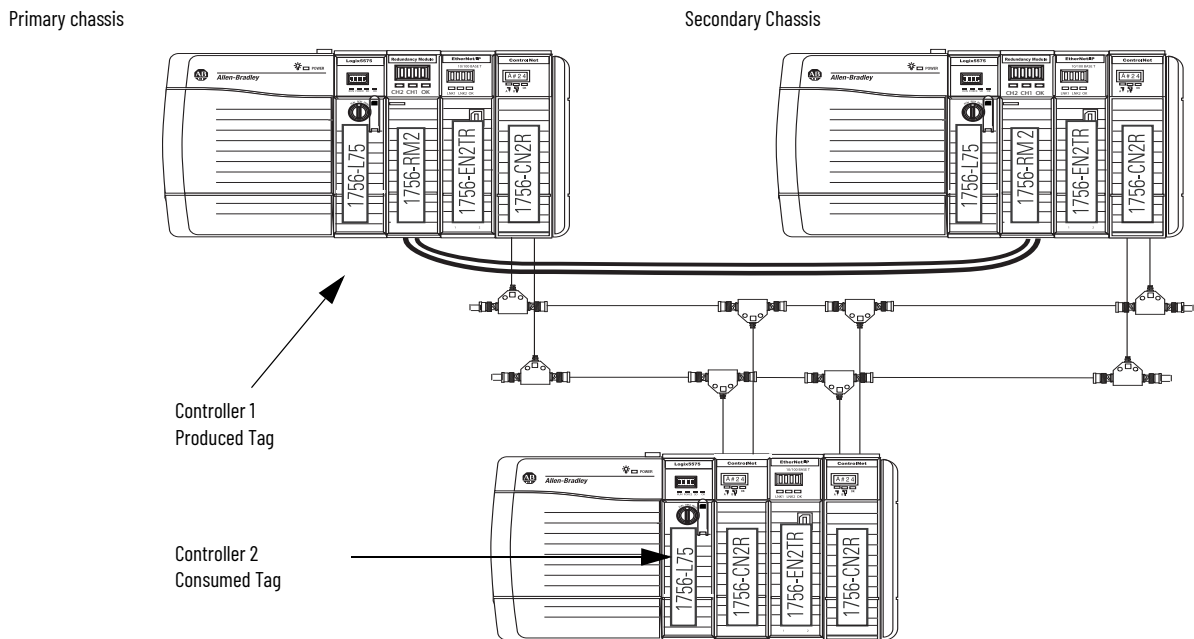

Keep these points in mind when you use produced and consumed connections over a ControlNet network in a redundancy system:

- During a switchover, the connection for tags that are consumed from a redundant controller can drop briefly.
 - The data does not update.
 - The logic acts on the last data that it received.

After the switchover, the connection is re-established and the data begins to update again.

- You cannot bridge produced and consumed tags over two networks. For two controllers to share produced or consumed tags, both must be attached to the same network.
- Produced and consumed tags use connections in both the controllers and the communication modules being used.
- Because the use of produced and consumed tags uses connections, the number of connections available for other tasks, such as the exchange of I/O data, is reduced.

The number of connections available in a system depends on controller type and network communication modules used. Closely track the number of produced and consumed connections to leave as many as necessary for other system tasks.

Network Update Time

The network update time (NUT) that you specify for your redundant system affects your system performance and your switchover response time. Typical NUTs used with redundant systems range from 5...10 ms.

NUTs with Multiple ControlNet Networks

You can choose to use multiple ControlNet networks with your redundancy system.

Figure 22 - Example of Two ControlNet Networks

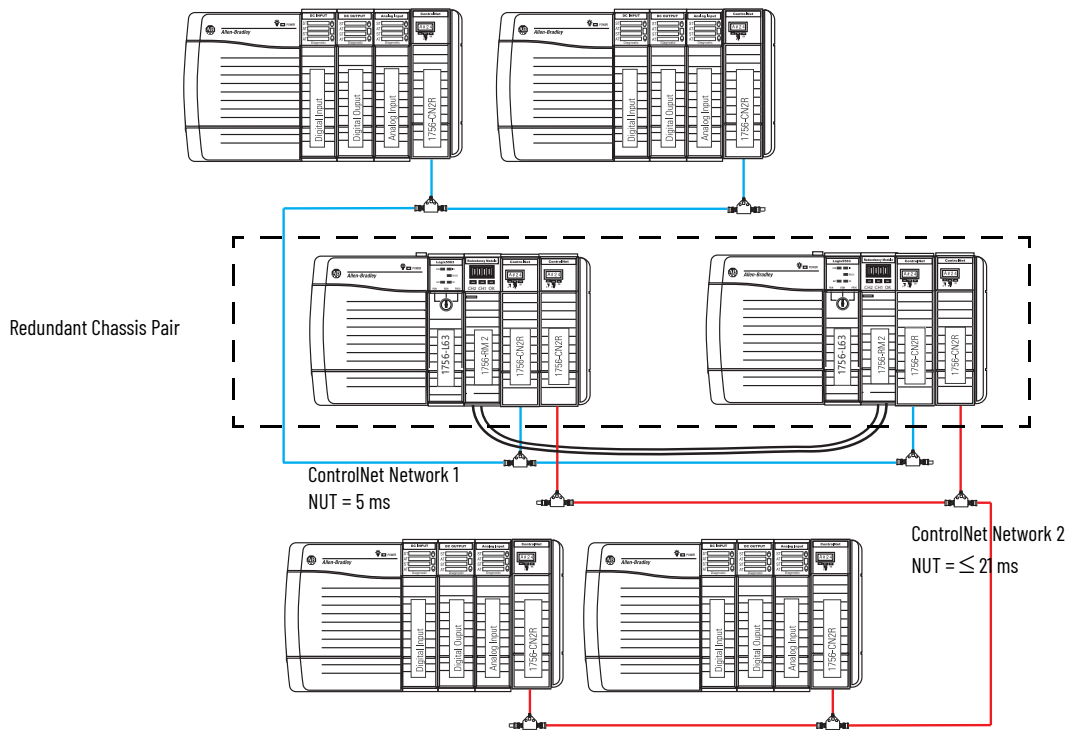

When you use multiple ControlNet networks, the networks must use compatible NUTs. Compatible NUTs are determined based on the network that uses the smallest NUT.

Use [Table 6](#) to determine the compatible NUTs for your system.

Table 6 - Compatible NUT Values for Multiple ControlNet Networks

If the smallest NUT of a network is (ms)	Then the largest NUT of any other network must be less than or equal to (ms)
2	15
3	17
4	19
5	21
6	23
7	25
8	27
9	29
10	31
11	33
12	35
13	37
14	39
15	41
16	43
17	46
18	48
19	50
20	52
21	55
22	57
23	59
24	62
25	64
26	66
27	68
28	71
29	73
30	75
31	78
32	80
33	82
34	84
35	87
36	89
37...90	90

Scheduled or Unscheduled Network

It is up to you to if you want to use a scheduled or unscheduled network.

Use a Scheduled Network

Schedule or reschedule your ControlNet network when you execute these tasks:

- Commission a new redundant system.
- Add a chassis of remote ControlLogix® I/O that is set to use the Rack Optimized communication format.
- Add any remote I/O besides ControlLogix I/O. For example, if you add FLEX™ I/O modules, you must schedule the network.
- Use produced/consumed data. If you add a produced/consumed data tag, you must reschedule the ControlNet network.

To schedule or reschedule your ControlNet network, you put your redundant system in Program mode.

Use an Unscheduled Network

You can use an unscheduled network when you:

- Add a remote I/O chassis of ControlLogix I/O that does not use the Rack Optimized communication format. That is, direct connections to the I/O are used.
- Add a ControlLogix I/O module to a chassis that has already been scheduled and uses the Rack Optimized communication format.
- Add some drives that support adding I/O while online.
- Use ControlNet to monitor HMI or the controller program execution online.

You can add those components to the unscheduled network while your redundant system is online and in Run mode. We recommend that you do not use an unscheduled network for all of your I/O connections.

The use of 1756-CN2, 1756-CN2R, and 1756-CN2RXT modules provide increased capacity for adding I/O while online compared to 1756-CNB or 1756-CNBR modules. With this increased capacity, you can easily add I/O and increase ControlNet connections that are used without affecting your redundant system performance.

Add Remote ControlNet Modules While Online

If you are adding a remote I/O chassis that is composed of a ControlLogix ControlNet module and ControlLogix I/O while your redundant system is running (online), make these considerations:

- Do not use Rack Optimized communication formats. The ControlNet module and I/O must be configured for direct connections.
- For each remote I/O module used, plan for one direct connection to be used.

Schedule a New Network

Complete these steps to schedule a new ControlNet network for a redundancy system.

IMPORTANT Before you schedule a ControlNet network, turn on the power to both redundant chassis.
If you schedule a ControlNet network while the secondary chassis is off, the keeper signature of a 1756-CN2 or 1756-CN2R module can mismatch its partner. This action can cause the secondary chassis to fail to synchronize.

1. Turn on the power to each chassis.
2. Start RSNetWorx™ for ControlNet software.
3. From the File menu, choose New.
4. At the New File dialog box, choose a configuration type.

This example uses ControlNet Configuration.

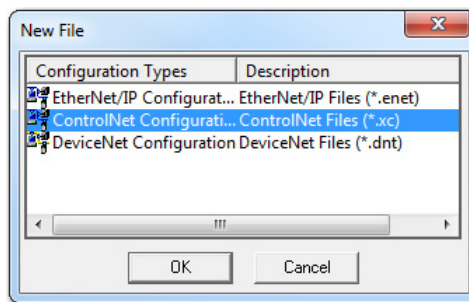

5. From the Network menu, choose Online.
6. Select your ControlNet network and click OK.
7. From the Network menu, choose Enable Edits.

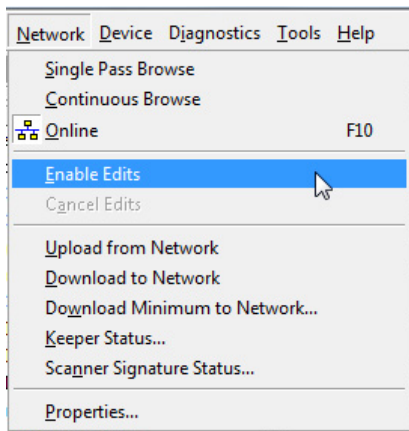

8. From the Network menu, choose Properties.

- In the Network Parameters tab, enter the parameters that are appropriate for your system.

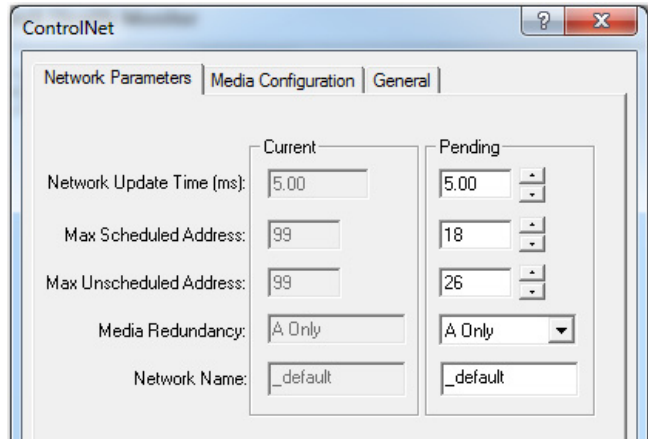

Parameter	Specify
Network Update Time (ms)	The minimum repetitive interval when data is sent over the ControlNet network.
Max Scheduled Address	The highest node number that uses scheduled communication on the network.
Max Unscheduled Address	The highest node number that you use on the network.
Media Redundancy	The ControlNet channels that you are using.
Network Name	A name for identifying the ControlNet network.

- On the Media Configuration tab, add repeaters, fiber, and coax to accurately represent your the worse case path between any two ControlNet nodes.

If the media configuration does not accurately represent the maximum propagation delay between any two nodes, your network may experience errors.

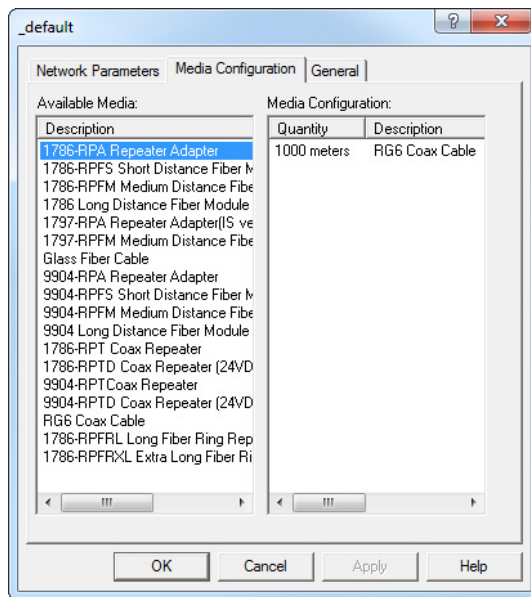

- Click Apply.
- Click OK.
- From the Network menu, choose Single Pass Browse.
- From the File menu, choose Save.

15. Type a name for the file that stores the network configuration, then click Save.
16. Click Optimize and rewrite Schedule for all Connections (default) and click OK.

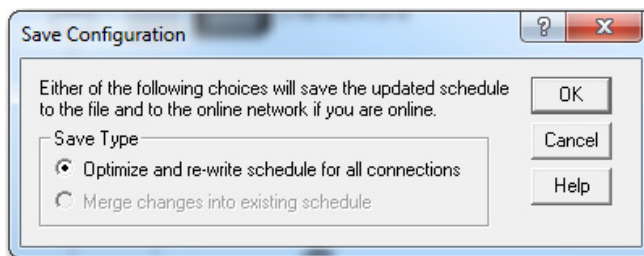

You have finished scheduling your new ControlNet network.

Update an Existing Scheduled Network

If you are adding the redundant chassis to an existing ControlLogix system that uses a ControlNet network, complete these steps to update the existing ControlNet network.

1. Turn on the power to each chassis.
2. Start RSNetWorx for ControlNet software.
3. From the File menu, choose Open.
4. Select the file for the network and click Open.
5. From the Network menu, choose Online.
6. From the Network menu, choose Enable Edits.

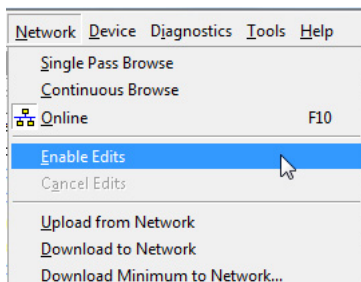

7. From the Network menu, choose Properties.

- In the Network Parameters tab, update the parameters specific to your system.

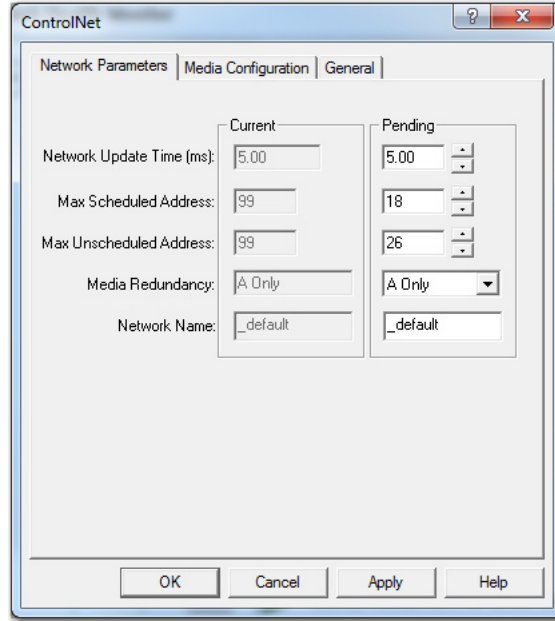

- Click OK.
- From the Network menu, choose Single Pass Browse.
- From the File menu, choose Save.
- Click Optimize and rewrite schedule for all connections and click OK.

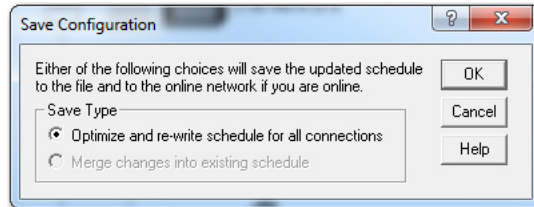

- Click OK.
You have completed updating your scheduled ControlNet network.

Check the Network Keeper States

After you schedule your ControlNet network, check the states of keeper-capable nodes. Checking the status of keeper-capable nodes is important because if a major network disruption occurs, the keepers provide network configuration parameters that are required to recover.

For more information about keepers and their function in a ControlNet network, see the ControlNet Network Configuration User Manual, publication [CNET-UM001](#).

To check the status of keepers on the ControlNet network, complete these steps.

1. In RSNetWorx for ControlNet software, from the Network menu choose Keeper Status.

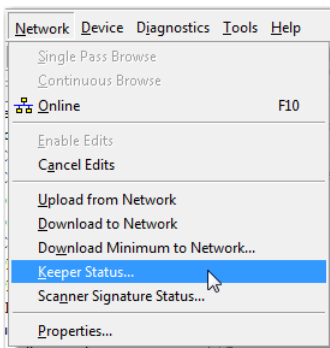

2. Verify that one keeper-capable device outside the redundant chassis is indicated as active and valid.
3. Verify that all keeper-capable devices on the network are valid.

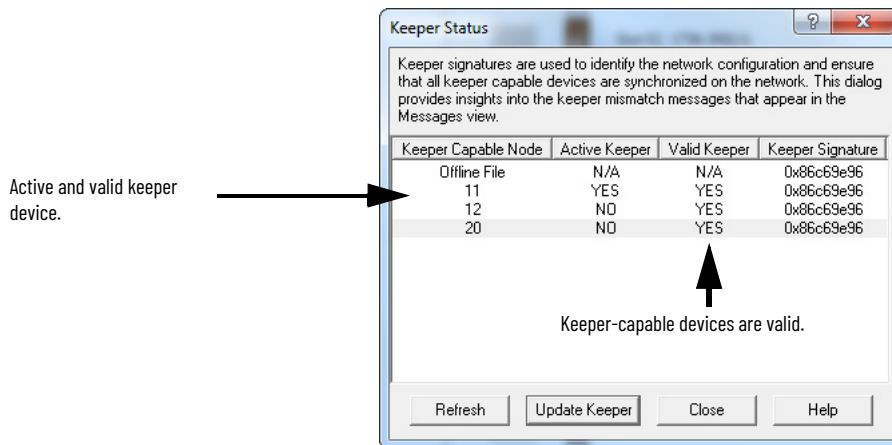

4. Verify that all nodes on the network have the same keeper signature.

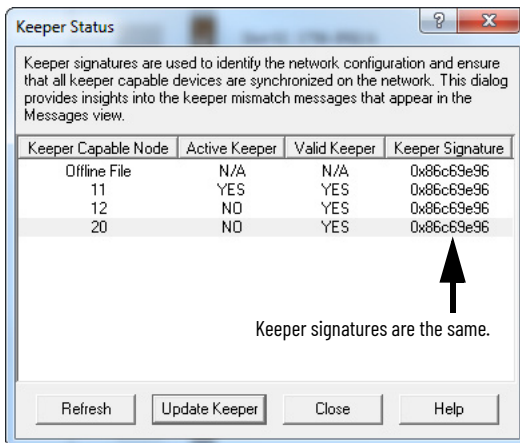



If the keeper signatures of partnered ControlNet modules are different, your redundant chassis can fail to synchronize.

If the keeper signatures of your partnered ControlNet modules are different, update the keepers of the redundant ControlNet modules.

Save the Project for Each Primary Controller

After you have scheduled your ControlNet networks, go online with each controller in your primary chassis, and upload and save the project. This process makes downloading a project easier in the future because you won't be required to reschedule the network after completing the download.

Automatic Keeper Crossloads

The 1756-CN2, 1756-CN2R, and 1756-CN2RXT ControlNet modules have an Automatic Keeper Crossload feature that makes replacing a ControlNet module in a redundant chassis easier. The Automatic Keeper Crossload feature also reduces the need to use RSNetWorx for ControlNet software once the system is running.

With the Automatic Keeper Crossload feature, ControlNet modules can automatically upload the keeper signature and network parameters from the active keeper of a ControlNet network.

To replace a ControlNet module that has been configured and scheduled on the ControlNet network, remove the existing module and insert a 1756-CN2, 1756-CN2R, or 1756-CN2RXT module. The module that you are inserting must be unconfigured or have a keeper signature of all zeros.



To clear the keeper signature of a 1756-CN2, 1756-CN2R, or 1756-CN2RXT module, complete these steps.

1. Disconnect the module from the ControlNet network and remove it from the chassis.
2. Set the node address switches to 00.
3. Insert the module back into the chassis and wait for the status display to indicate Reset Complete.
4. Remove the module and set the node address switches to the intended node address.
5. Insert the module into the chassis.

After being inserted and connected to the ControlNet network, the unconfigured 1756-CN2, 1756-CN2R, and 1756-CN2RXT modules crossload the appropriate configuration from the active keeper on the ControlNet network. The modules then become configured with the appropriate keeper signature.

Configure the Redundancy Modules

Topic	Page
About the Redundancy Module Configuration Tool (RMCT)	75
Determine If Further Configuration Is Required	76
Use the RMCT	76
Module Info Tab	81
Configuration Tab	82
Synchronization Tab	85
Synchronization Status Tab	88
System Update Tab	89

About the Redundancy Module Configuration Tool (RMCT)

The Redundancy Module Configuration Tool (RMCT) is used to configure the redundancy modules and to determine the status of the redundancy system.

Use the RMCT to complete these configuration-related tasks:

- Set Auto-Synchronization parameters.
- Set the time and date of redundancy modules.
- View and set module information.
- View and set Chassis ID parameters (Chassis A, Chassis B).
- Lock the redundant system for an update.
- Conduct a test switchover.

You can also use this functionality available with the RMCT to determine the status of the redundant system:

- View error diagnostics specific to redundant chassis.
- View qualification and compatibility status of partnered modules.
- Identify noncompliant modules for removal.
- View redundant system event history.

-
- IMPORTANT**
- With 1756-Lxx Enhanced Redundancy Bundle revision 34.051_kit1 and later, RSLinx RMCT is no longer supported. You must download FactoryTalk RMCT version 9.00.00, it is not included in the bundle.
 - FactoryTalk Linx RMCT version 9.00.00 or later supports the 1756-RM2 module with firmware version 20.010 or later. You must use the FactoryTalk Linx RMCT with FactoryTalk Linx.
 - For 1756-Lxx Enhanced Redundancy Bundle revision 33.052_kit1 and earlier, you must use the RSLinx RMCT version 8.05.01 together with RSLinx Classic.
 - For 1756-Lxx Enhanced Redundancy Bundles 20.058_kit1...33.052_kit1, RSLinx RMCT is included in the redundancy bundle and is not available as an individual download.
 - For 1756-Lxx Enhanced Redundancy Bundles 20.057_kit1 and earlier, you download the RMCT separately on PCDC as a product add-on.
-

Determine If Further Configuration Is Required

The default configuration of the redundancy modules lets you synchronize your redundant chassis without additional configuration if you are using a basic redundant chassis pair.

However, some applications and uses of the redundancy system can require additional configuration. For example, you must use the RMCT for additional configuration if you must complete any of these tasks:

- Set the redundancy modules to a different time or date (recommended).



If you set the time and date of a redundancy module per the workstation time and date, it can be helpful in analyzing redundancy logs in the future.

- Program your controller to control the redundant system.
- Change the redundancy synchronization options of the redundant system.
- Change the synchronization states of your redundant chassis.
- Conduct a test switchover.
- Complete a firmware update of a module in the redundant chassis while the system is online.

If you must complete any of these tasks, see the sections that follow.

Use the RMCT

To access and begin using the RMCT, launch the communication software and browse to your redundancy module. Right-click the redundancy module and choose Module Configuration.

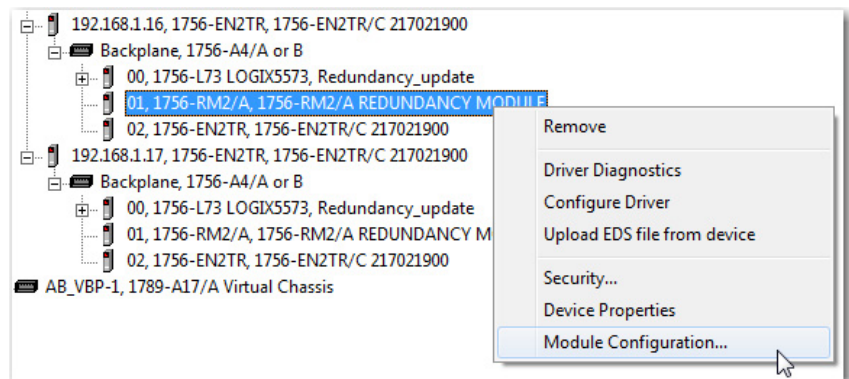

If you cannot see the Module Configuration option in the list, then the compatible version of the RMCT is not installed.

When you access the RMCT, the dialog box always indicates the status of the redundancy chassis in the bottom-left corner.

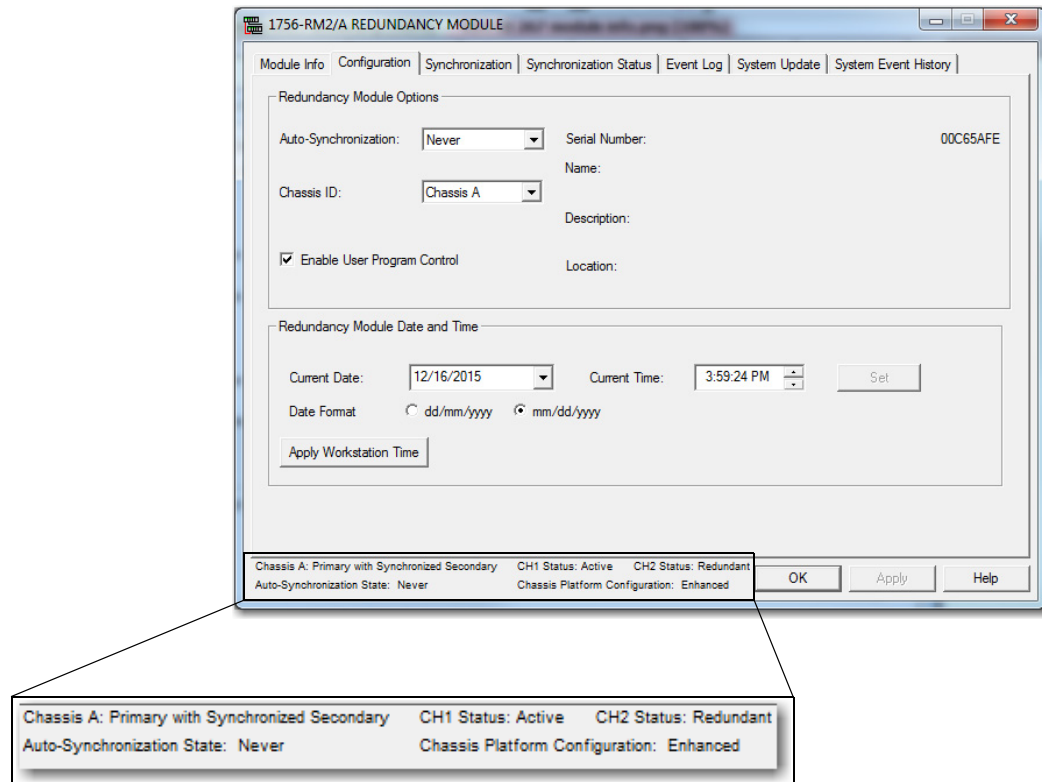

Identify the RMCT Version

You must use a version of the RMCT that is compatible with your redundancy module firmware.

Beginning with version 20.054, the redundancy module firmware reports back to the Redundancy Module Configuration Tool (RMCT) as to which version of the RMCT is compatible. If there is an incompatibility, the RMCT shows only the Module Info tab and indicates the version that the firmware is compatible with.

For more information on the RMCT compatibility, see Knowledgebase Technote [Redundancy Module Configuration Tool \(RMCT\)](#).

Complete these steps to check or verify the version of the Redundancy Module Configuration Tool (RMCT) that you have installed.



The RMCT launches at the version that is compatible with the 1756 redundancy module firmware that is installed.

If you have not updated your 1756 redundancy module firmware after upgrading your RMCT version, the RMCT version that is indicated can differ from version you updated to. You can also check the RMCT version that you have installed by using Add or Remove Programs in the Control Panel.

1. Launch the communication software.
2. Click the RSWho icon.



- Right-click your redundancy module and choose Module Configuration.

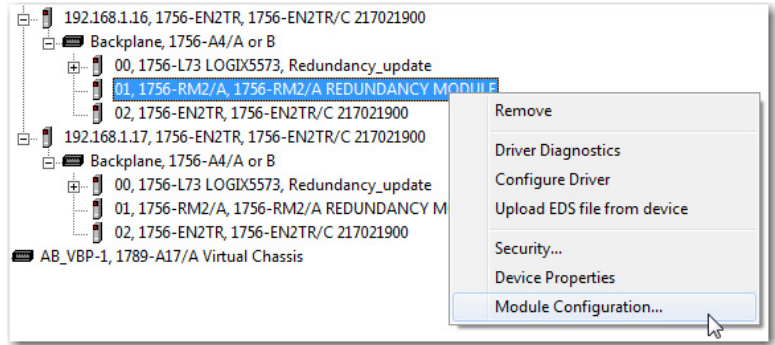

The Module Configuration dialog box opens.

- Right-click the title bar and choose About.

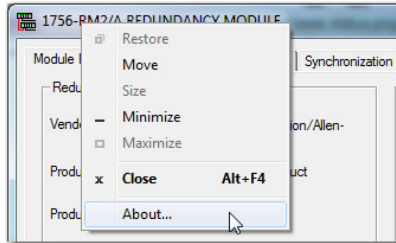

The About dialog box opens and indicates the RMCT version.

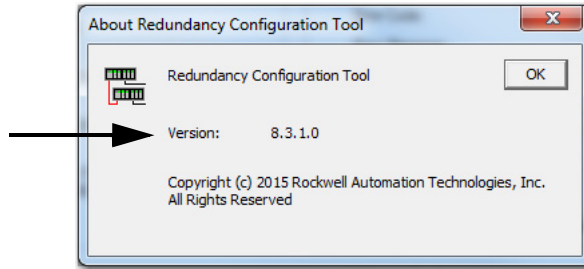

This should show the version you need based on your bundle or higher. The RMCT always shows the latest version installed, and later versions are backwards compatible with earlier versions.

Update the RMCT Version

The RMCT version that is compatible with your redundancy module firmware is included in the downloads of some redundancy bundles.

- 1756-Lxx Enhanced Redundancy Bundle revision 34.051_kit1 or later does not include FactoryTalk RMCT. FactoryTalk Linx RMCT is available as a separate Product Add-On download on the Product Compatibility & Download Center (PCDC) to use with FactoryTalk Linx.

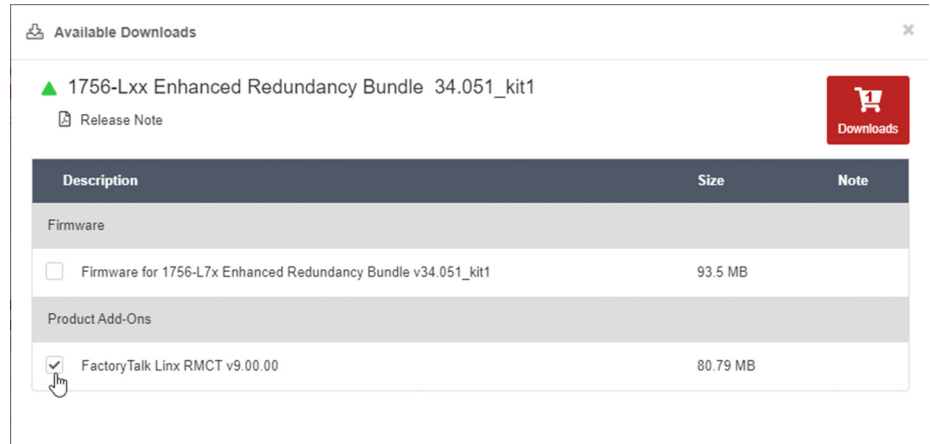

Available Downloads

▲ 1756-Lxx Enhanced Redundancy Bundle 34.051_kit1 Downloads

📄 Release Note

Description	Size	Note
Firmware		
<input type="checkbox"/> Firmware for 1756-L7x Enhanced Redundancy Bundle v34.051_kit1	93.5 MB	
Product Add-Ons		
<input checked="" type="checkbox"/> FactoryTalk Linx RMCT v9.00.00	80.79 MB	

- For 1756-Lxx Enhanced Redundancy Bundles 20.058_kit1...33.052_kit1, RSLinx RMCT is included in the downloaded redundancy bundle.

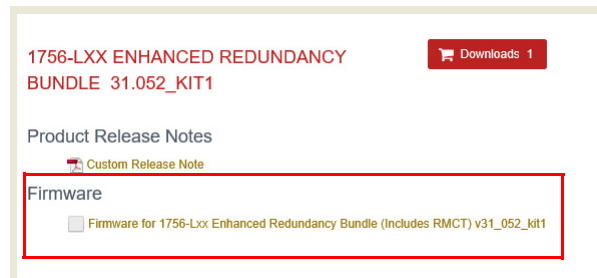

1756-LXX ENHANCED REDUNDANCY BUNDLE 31.052_KIT1 Downloads 1

Product Release Notes

📄 Custom Release Note

Firmware

Firmware for 1756-Lxx Enhanced Redundancy Bundle (Includes RMCT) v31_052_kit1

- For redundancy bundles that use a firmware revision earlier than 20.007, you can download the RMCT separately as a product add-on:
 1. Go to [Find Downloads](#).
 2. Search for your controller.
 3. Search for the redundancy module.
 4. You can select the RMCT as part of the Product Add-Ons download.

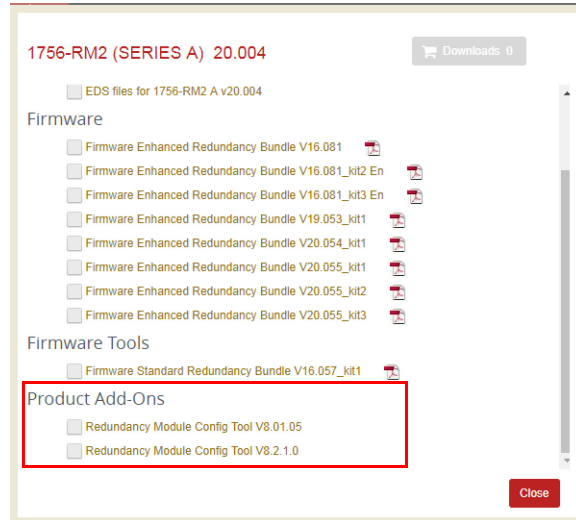

To install the RMCT:

1. Browse to the RMCT directory on your computer.
2. Double-click setup.exe.
3. On the RMCT Setup dialog, click Next.
4. When the installation is complete, click Finish.

Module Info Tab

The Module Info tab of the RMCT provides a general overview of the identification and status information of the redundancy module. This status information is updated approximately once every two seconds.

The screenshot shows the '1756-RM2/A REDUNDANCY MODULE' configuration window. The 'Module Info' tab is active, displaying the following information:

- Redundancy Module Identification:**
 - Vendor: Rockwell Automation/Allen-Bradley
 - Product Type: Redundancy Product
 - Product Code: 3
 - Revision: 20.5.3
 - Serial Number: 00C65AFE
 - Product Name: 1756-RM2/A REDUNDANCY MODULE
- Status:**
 - General State: OK
 - Major Fault: None
 - Minor Fault: None
 - Error Code:
 - Error Message:
 - Recovery Message:
- Fiber Channel Switchover Counters:**
 - Total: 4
 - Periodic: 0
 - Max Periodic: 1 12/16/2015 14:48:11:596
 - Reset button
- User-Defined Identity:**
 - Name:
 - Description:
 - Location:
 - Change... button

At the bottom of the window, the status is summarized: Chassis A: Primary with Synchronized Secondary, CH1 Status: Active, CH2 Status: Redundant, Auto-Synchronization State: Always, Chassis Platform Configuration: Enhanced. Buttons for OK, Apply, and Help are also present.



Not all indicators are shown for 1756-RM/A and 1756-RM/B modules.

These parameters are indicated in the Module Info tab.

Parameter	Description
Vendor	Name of the vendor of the redundancy module.
Product Type	General product type of the redundancy module.
Product Code	CIP™ product code for the redundancy module.
Revision	Major and minor revision information for the redundancy module.
Redundancy Module Serial Number	Serial number of the redundancy module.
Product Name	Predefined catalog name of the redundancy module.
General Status	General state of the redundancy module. Possible values include Startup, Load, Fault, and OK.
Major Fault	The major fault status of a redundancy module. When a major fault is detected, the system does not provide redundancy support.
Minor Fault	The minor fault status of a redundancy module. When a minor fault is detected, the system continues to provide redundancy support.
Error Code	Error code that is related to the fault if one exists.
Error Message	Text-based message that describes the error if a fault exists.
Recovery Message	Text-based message that indicates the recovery from a fault.
Total	Indicates the number of channel switchovers that have occurred from CH1 to CH2 and vice versa on the module since its last powerup. It is reset to 0 automatically by firmware on a power cycle.
Periodic	Indicates the number of switchovers that have occurred between CH1 and CH2 over the last 10-second interval. The counter is constantly updated to reflect the value that is recorded at every 10-second interval. The counter is automatically reset to 0 on a power cycle.

Parameter	Description
Max Periodic Switchovers	The maximum number that is recorded in the Periodic counter. The time of the update is recorded every time that the counter is updated. The counter is automatically reset to 0 on a power cycle and can also be reset by clicking the Reset button. ⁽¹⁾
CH1 Status	Fiber Channel 1 status. The status shows the operating condition of the respective fiber channels in terms of one of the following values: <ul style="list-style-type: none"> - Unknown - Operating state is not yet determined - Active - Channel is operating normally as the ACTIVE channel - Redundant - Channel is operating normally as the REDUNDANT channel - Link Down - Channel is disconnected. Causes can be: the cable is disconnected/broken/damaged; signal is attenuated, connector is loose, the partner 1756-RM2 module is power down or in a major fault state - No SFP - No transceiver was detected, it has failed, it is loosely connected, it is not installed - SFP !Cpt - Transceiver is not a Rockwell Automation supported unit - SFP Fail - Transceiver is in a failed state
CH2 Status	Fiber Channel 2 status. See CH1 Status on page 82 .
Chassis Platform Configuration	Indicates configuration (version 19.05x and later always displays 'enhanced').

(1) The Periodic counters can be used to identify a burst of switchovers that can take place due to intermittent channel failures within a few seconds. The recorded time can be helpful to correlate the switchover occurrences with any external failures that have occurred on the fiber cables.

In addition, you can click Change to edit the User-Defined Identity parameters to meet your application needs.

Configuration Tab

Use the Configuration tab to set redundancy options and the internal clock of the redundancy module. After you modify a parameter, the Apply Workstation Time button becomes active.

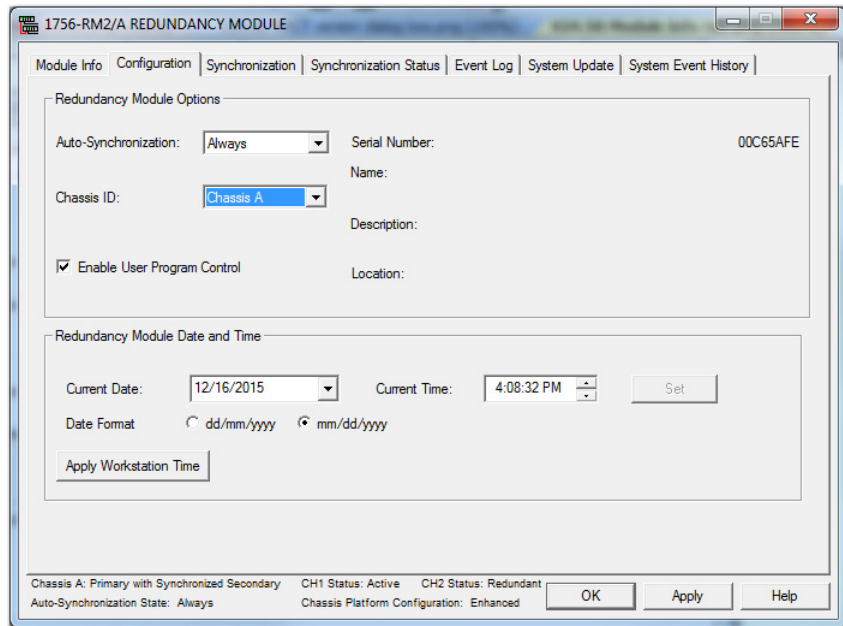

Auto-synchronization

The first parameter in the Configuration tab is the Auto-Synchronization parameter. The value that you chose for this parameter determines a significant part of your redundant system behavior.



Verify that your Auto-Synchronization parameter is at the proper value **before** you modify your redundant system. This verification helps prevent system errors. For example, if you are upgrading your redundant system firmware, verify that this parameter is set to Never or Conditional before disqualifying your secondary chassis. If this parameter is Always, you cannot properly disqualify your chassis and conduct the update.

Use the following table to determine the Auto-Synchronization setting that best suits your application.

If you use this parameter	This synchronization behavior results
Never	<p>The system remains in the same state, that is, either synchronized or disqualified, until one of these events takes place:</p> <ul style="list-style-type: none"> • A command is issued from the RMCT to either synchronize or disqualify. • The controller commands synchronization or disqualification by using a MSG instruction. For this action to occur, Enable User Program Control must be checked. • A fault on the primary causes a switchover.
Always	<p>The system automatically synchronizes regularly. If you attempt to disqualify the system by using the Disqualify Secondary command in the RMCT, the resulting disqualification is temporary as the system automatically qualifies and synchronizes again. If the controller program disqualifies the system, the resulting disqualification is also temporary.</p>
Conditional	<p>The system behavior with this setting is dependent on the Auto-Synchronization state of your system, found in the lower left portion of the RMCT window after setting the Auto-Synchronization parameter to Conditional:</p> <ul style="list-style-type: none"> • If your Auto-Synchronization parameter is set to Conditional and your Auto-Synchronization state is 'Conditional, Enabled', then the system continually attempts to synchronize. • If your Auto-Synchronization parameter is set to Conditional and your Auto-Synchronization state is 'Conditional, Disabled', then the system does not automatically attempt to synchronize. <p>To change from 'Conditional, Enabled' to 'Conditional, Disabled', click Disqualify Secondary on the Synchronization tab. To change from 'Conditional, Disabled' to 'Conditional, Enabled', click Synchronize Secondary on the Synchronization tab.</p>

Chassis ID

The chassis ID parameter is used to assign a generic label to the chassis that house the redundancy modules. The available chassis labels are Chassis A and Chassis B.

If you change the chassis label in the RMCT of the primary redundancy module, the secondary module and chassis are automatically assigned the other chassis label.

The chassis label that is assigned to the module remains associated with the same physical chassis, regardless of its primary or secondary control designation.

Enable User Program Control

Check Enable User Program Control in the Configuration tab if you plan to use MSG instructions in your controller program to initiate a switchover, change the redundancy module time, or synchronize.

If you leave Enable User Program Control unchecked, the redundancy modules do not accept any commands from the controller.

Redundancy Module Date and Time

The Redundancy Module Date and Time parameters can be applied separate from the Redundancy Module Options parameters. The time that is specified with these parameters is the time that the event logs reference when a redundant system event occurs.

To change the redundancy module time settings, use the pull-down menu or type your changes then click Set to implement time changes. Or, to set the time of the redundancy module to match that of the workstation, click Apply Workstation Time.

IMPORTANT We recommend that you set the redundancy module date and time when you commission a system. We also recommend that you periodically check the date and time settings to make sure that they match the settings of the controller.

If a power failure occurs on the redundant chassis, you must reset the date and time information of the redundancy modules. The modules do not retain those parameters when power is lost.

Synchronization Tab

The Synchronization Tab has commands for these options:

- Change the synchronization state of the system (synchronize or disqualify)
- Initiate a switchover
- Force the disqualified secondary to become the primary

The commands are described in the [Commands in the Synchronization Tab](#) section on [page 86](#).

This tab also has information about the last four synchronization attempts in the Recent Synchronization Attempts log. N or N-X identify synchronization attempts in the log. If the redundant chassis fail to synchronize, a cause is identified in the Recent Synchronization Attempts log.

The causes and their interpretations are described in the [Recent Synchronization Attempts Log](#) section on [page 87](#).

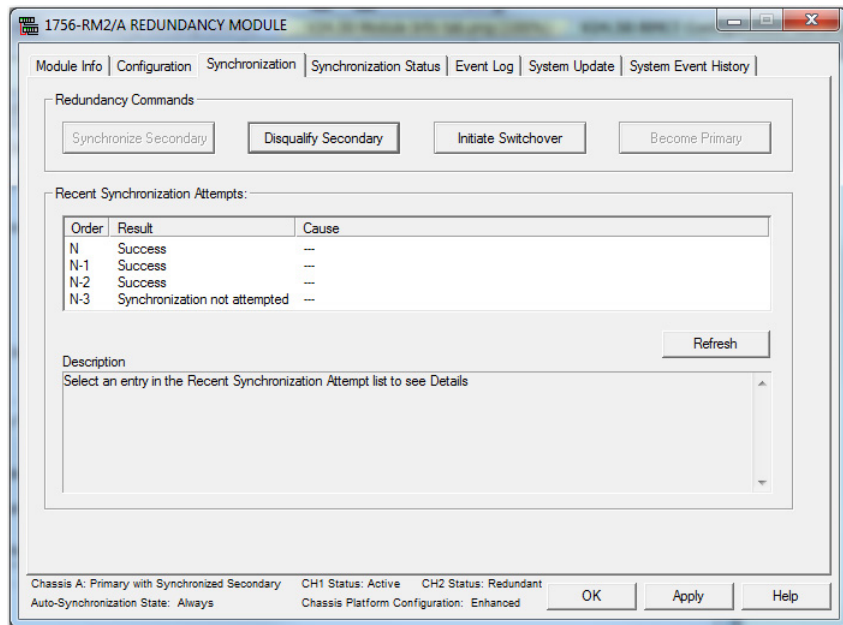

Commands in the Synchronization Tab

These sections explain each redundancy command and the system conditions that are required for the command to be available.

Command	Description
Synchronize Secondary	<p>This command forces the primary redundancy module to attempt synchronization with its partner. This command is available in specific conditions:</p> <ul style="list-style-type: none"> Available only when the chassis redundancy state is as follows: <ul style="list-style-type: none"> Primary with Disqualified Secondary Disqualified Secondary Unavailable (dimmed) in all other chassis states <p>Synchronization is asynchronous with the execution of this command. Successful execution of this command begins with synchronization, which can take several minutes. Monitor the chassis status that is displayed at the bottom of the RMCT to determine when synchronization has completed.</p>
Disqualify Secondary	<p>This command forces the primary redundancy module to disqualify its partner.</p> <hr/> <div style="display: flex; align-items: center;">  <div> <p>ATTENTION:</p> <ul style="list-style-type: none"> Disqualifying the secondary chassis makes it unable to assume control functions, that is, redundancy is lost. If you disqualify the secondary and a major fault occurs on the remaining primary, a switchover does not occur. </div> </div> <hr/> <p>This command is available in specific conditions:</p> <ul style="list-style-type: none"> Available only when the chassis redundancy state is as follows: <ul style="list-style-type: none"> Primary with Synchronized Secondary Synchronized Secondary Unavailable (dimmed) in all other chassis states <p>If you use the Disqualify Secondary command when the Auto-Synchronization parameter is set to Always, a synchronization attempt occurs immediately after the secondary chassis becomes disqualified.</p> <p>To keep the secondary disqualified after issuing a Disqualify Secondary command, set the Auto-Synchronization parameter to Conditional or Never before disqualifying the secondary.</p>
Initiate Switchover	<p>This command forces the system to initiate an immediate switchover from the primary chassis to the secondary chassis. This command can be used when you upgrade redundancy system firmware or when you complete maintenance on one chassis of the redundant pair.</p> <p>This command can also be used to perform a realistic test of your redundant system behavior by simulating a failure that is detected in the primary control chassis.</p> <p>This command is available in specific conditions:</p> <ul style="list-style-type: none"> Available only when the chassis redundancy state is as follows: <ul style="list-style-type: none"> Primary with Synchronized Secondary Synchronized Secondary Unavailable (dimmed) in all other chassis states
Become Primary	<p>This command forces a disqualified secondary system to become a primary system and is available in specific conditions:</p> <ul style="list-style-type: none"> Available only when the chassis redundancy state is Secondary with No Primary. Unavailable (dimmed) in all other chassis states

Recent Synchronization Attempts Log

This table describes the possible result and causes of synchronization states.

Result	Result Interpretation
Undefined	The result of the synchronization is unknown.
No attempt since last powerup	Synchronization has not been attempted since power was applied to the module.
Success	Full synchronization was successfully completed.
Abort	The synchronization attempt failed. See Table 7 for further information.

If the Synchronization Attempts log indicates that the Synchronization attempt was aborted, use [Table 7](#) to diagnose the cause.

Table 7 - Synchronization Interpretation

Cause	Cause Interpretation
Undefined	The cause of synchronization failure is unknown.
Module Pair Incompatible	Synchronization was aborted because one or more module pairs are incompatible.
Module Configuration Error	Synchronization was aborted because one of the modules is improperly configured.
Edit Session In Progress	Synchronization was aborted because an edit or session is in progress.
Crossloading Failure	An undetermined failure occurred during synchronization between redundancy modules.
Comm Disconnected	The cable between the redundancy modules was disconnected.
Module Insertion	Synchronization was aborted because a module was inserted into a chassis.
Module Removal	Synchronization was aborted because a module was removed from a chassis.
Secondary Module Failed	Synchronization was aborted because of a failure in the secondary module.
Incorrect Chassis State	Synchronization was aborted due to an incorrect chassis state.
Comm Does Not Exist	Synchronization could not be performed because the communication link between redundancy modules does not exist.
Non-redundant Compliant Module Exists	Synchronization could not be performed because one or more non-redundant modules are present in one of the chassis.
Sec Failed Module Exists	A module in the secondary chassis has asserted the SYS_FAIL line, which indicates that it has faulted or failed.
Local Major Unrecoverable Fault	Synchronization was aborted because of a local major unrecoverable fault.
Partner Has Major Fault	Synchronization was aborted because the partner module has a major fault.
Sec SYS_FAIL_L Subsystem Failed	The test of the SYS_FAIL line in the secondary chassis failed.
Sec RM Device Status = Comm Error	Synchronization was aborted because the status of the secondary redundancy module indicates a communication error.
Sec RM Device Status = Major Recoverable Fault	Synchronization was aborted because the status of the secondary redundancy module indicates a major recoverable fault.
Sec RM Device Status = Major Unrecoverable Fault	Synchronization was aborted because the status of the secondary redundancy module indicates a major unrecoverable fault.
Incorrect Device State	Synchronization was aborted because the device is in the wrong state.
Primary Module Failed	Synchronization was aborted because of a failure in the primary module.
Primary Failed Module Exists	A module in the primary chassis has asserted the SYS_FAIL line, which indicates that it has faulted or failed.
Auto-Sync Option	Synchronization was aborted because the Auto-Synchronization parameter of one of the redundancy modules was changed during synchronization.
Module Qual Request	Synchronization was aborted because another synchronization request was received. The current synchronization has stopped so that the new synchronization request can be serviced.

Table 7 - Synchronization Interpretation (Continued)

Cause	Cause Interpretation
SYS_FAIL_L Deasserted	Synchronization was aborted because one of the modules came out of a faulted or failed state.
Disqualify Command	Synchronization was aborted because the redundancy module received a disqualify command from another device. The originating device sends this command when it can no longer perform in the qualified state.
Disqualify Request	Synchronization was aborted because the redundancy module received a disqualify command from another device. The originating device sends this command when it can no longer perform in the qualified state.
Platform Configuration Identity Mismatch Detected	There are modules in the primary or secondary chassis that do not belong to the platform.
Application Requires Enhanced Platform	A redundant controller is running an application that contains a feature that is qualified to run only on an enhanced redundant platform, for example, Alarms.
ICPT Asserted	A test line on the backplane is asserted.
Unicast Not Supported	A unicast connection is configured in the redundant controller, and redundancy systems do not support Unicast.
PTP Configuration Error	The PTP clock of a redundant controller is not synchronized or the partner controller pair is synchronized to another Grandmaster.
Secured Module Mismatch	A mismatch was detected between a primary and secondary secured module.

Synchronization Status Tab

The Synchronization Status tab provides a module-level view of these items:

- Synchronization state (for example, Synchronized or Disqualified)
- Chassis designation (Primary or Secondary)
- Module compatibility with its partner (for example, Full or Undefined)

Each module that is installed in the chassis is identified and information regarding its partner and compatibility are provided.

Synchronization State
Chassis Designation
Module-partner Compatibility

Slot	% Complete	Module Name	Module Revision	Secondary Readiness	State	Compatibility
0	100	DB_1756-L73/A INT_7xR...	24.50	Synchronized	Primary	Full
1	100	1756-RM2/A REDUNDAN...	20.5	Synchronized	Primary	Full
2	100	1756-EN2TR/C 217021900	10.7	Synchronized	Primary	Full
3	--	<empty>	--	--	--	--

System Update Tab

Use of the commands in the System Update tab lets you perform firmware updates in the secondary chassis while the primary chassis remains in control. Reference the lock and switchover logs in this tab for update information when completing a firmware update.



ATTENTION: When performing firmware updates by using commands in the System Update tab, redundancy is lost. In the event of a fault on the operating primary chassis, the system cannot switch control to the secondary chassis.

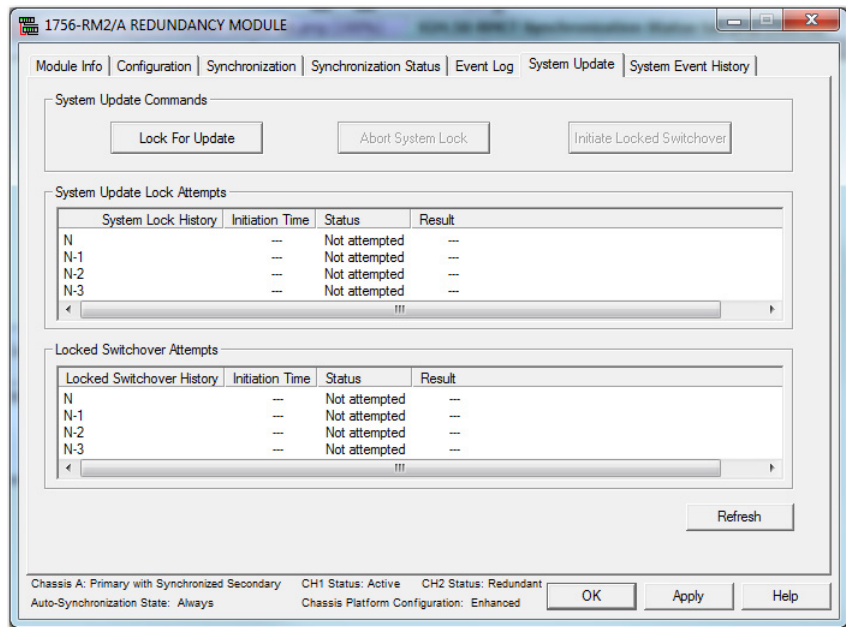

System Update Commands

The three system update commands are available only when accessing a primary redundancy module. These commands are not available when accessing the secondary redundancy module.



While you are completing tasks to update the system by using the system update commands, you cannot access these tabs in the RMCT:

- Configuration
- Synchronization
- Synchronization Status

If you attempt to access any of these tabs while the system is locked or is completing a locked switchover, it results in an error dialog box.

Lock For Update

The Lock for Update command lets you synchronize a redundant chassis pair under these conditions:

- The secondary redundancy module uses updated firmware and an updated programming software application program version.
- The running primary redundancy module uses a previous firmware revision and previous programming software application program version.

The Lock for Update command is available only when all modules in the primary chassis have no compatibility anomalies. Before issuing the lock command, verify that you have completed these tasks:

- Set the Auto-Synchronization option in the Configuration tab to Never.
- Disqualify the secondary chassis by using the Disqualify Secondary command in the Synchronization tab of the RMCT of the secondary redundancy module.
- Updated the primary and secondary redundancy modules to compatible firmware revisions.
- Updated all other modules in the secondary chassis to their intended firmware revisions.
- Configured the controller project that as required to accommodate the update and replacement of modules if needed.

For details about how to complete those tasks, see [Update Redundant Firmware on page 48](#).

Click the Lock for Update command to initiate the locking process. The lock can take several minutes to finish. Monitor the System Update Lock Attempts log to determine when the lock is complete. In addition, the chassis status that is shown at the bottom-left of the dialog box changes from Primary with Disqualified Secondary to Primary Locked for Update.

Figure 23 - Lock for Update Status Updates

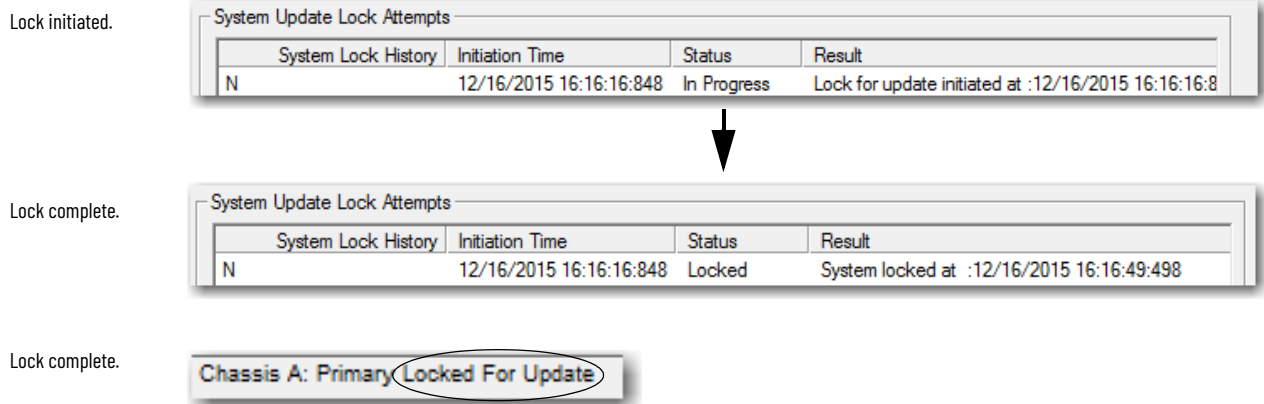

Abort System Lock

The Abort System Lock command can be used to stop the system lock. It is available as soon as a lock for update is initiated.

Click Abort System Lock to return the redundant chassis status to Primary with Disqualified Secondary. This action also causes the system update to stop and the program in the secondary controller to clear. If you click Abort System Lock, you must download the program to the secondary controller before reattempting a Lock for Update.

Initiate Locked Switchover

The Initiate Locked Switchover command is available only when the chassis redundancy state is Primary with Locked Secondary. That is, the Initiate Locked Switchover is available only after the lock for update is complete.

If you click Initiate Locked Switchover, your secondary chassis assumes control and becomes the new primary. The old primary is now the new secondary chassis and you can update the firmware of the modules in the new secondary chassis.

Figure 24 - Illustration of Switchover

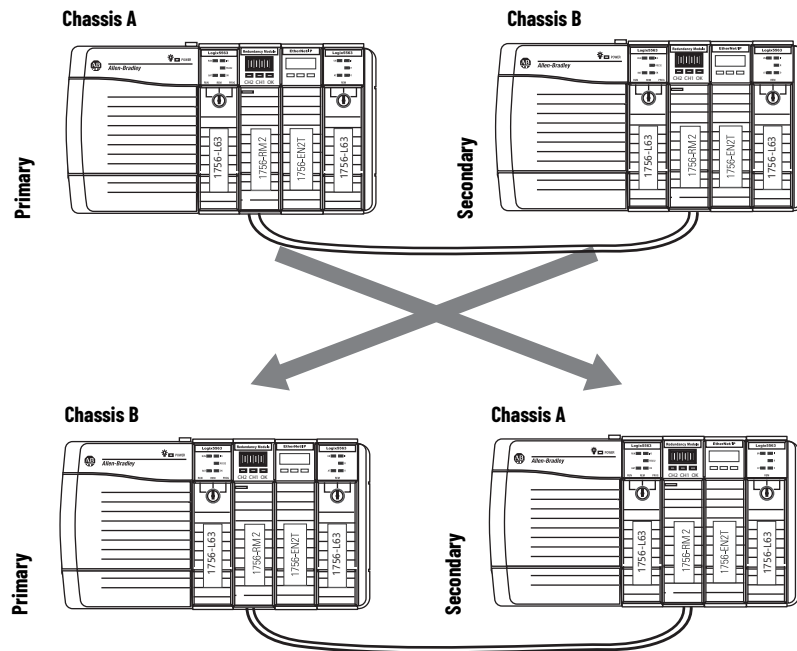

The difference between a locked switchover and a normal switchover is that you initiate the locked switchover. You or a fault in the primary chassis initiate a normal switchover.

System Update Lock Attempts

The System Update Lock Attempts is where attempts to lock the system are logged. This log displays the last four lock attempts and provides this information specific to each attempt:

- Time and date
- Status (for example, Locked or Abort)
- Result (for example, System Locked or Invalid Response Received)

The status indicated in the System Update Lock Attempts log can be any one of the states that are listed in [Table 8](#).

Table 8 - Status

Status	Interpretation
Not Attempted	A system lock has not been attempted since the last powerup.
In Progress	A lock is in progress.
Locked	The lock was successfully completed.
Abort	The lock attempt failed. The reason for the failure is indicated in a Result field.

If your status is indicated as Abort, one of these conditions can exist:

- An error occurred while communicating with the partner redundancy module.
- A module in the secondary chassis does not have a partner in the primary chassis.
- A module pair is incompatible.
- The SysFail test was unsuccessful in the primary redundancy module.
- A Major Recoverable Fault occurred in primary redundancy module.
- A Major NonRecoverable Fault occurred in primary redundancy module.
- A module was inserted into the chassis.
- A module was removed from the chassis.
- A failed module exists in the secondary chassis.
- A failed module exists in the primary chassis.
- An Abort System Update command received.
- Invalid response was received from a module.
- A module rejected the state change.
- A platform mismatch was detected.

For more information on Lock for Update Failures, see the Knowledgebase Technote [Lock for Update Fails](#).

Locked Switchover Attempts

The Locked Switchover Attempts log provides information about the status of the last four locked switchover attempts. This log includes this information about each attempt:

- Time and date
- Status
- Result

The status indicated in the Locked Switchover Attempts log can be any one of the states that are listed in [Table 9](#).

Table 9 - Status

Status	Description
Not Attempted	A locked switchover has not been attempted since the last powerup.
In Progress	A locked switchover is in progress.
Success	A locked switchover was successfully completed.
Abort	The locked switchover attempt failed. The cause of the failure is indicated in a Result field.

If a locked switchover is aborted, it can be because of the following:

- A module declined a locked switchover readiness request.
- An invalid response was received from the locked switchover readiness request.
- After an initiate switchover prompt, a module rejected the command.
- After an initiate switchover prompt, a module replied with an invalid response.

Program the Redundant Controller

Topic	Page
Configure the Redundant Controller	93
Enable Time Synchronization	95
Crossloads, Synchronization, and Switchovers	96
Crossloads and Scan Time	100
Program to Minimize Scan Times	103
Program to Maintain Data Integrity	108
Optimize Task Execution	111
Conduct a Test Switchover	115
Program Logic to Run After a Switchover	117
Use Messages for Redundancy Commands	118
Set the Task Watchdog	121
Download the Project	123
Store a Redundancy Project to Nonvolatile Memory	123
Online Edits	126

Configure the Redundant Controller

Both controllers in the ControlLogix® redundancy system operate by using the same program. You do not need to create a project for each controller in the redundant system.

IMPORTANT When programming your redundancy system, you should only interface with the controller in the primary rack unless a specific workflow dictates that the controller in the secondary rack should be the target of modification.

To configure your controllers to operate in a redundant system, complete these steps.

1. Open or create a project for your redundant controller.
2. Access the Controller Properties dialog box for the controller.

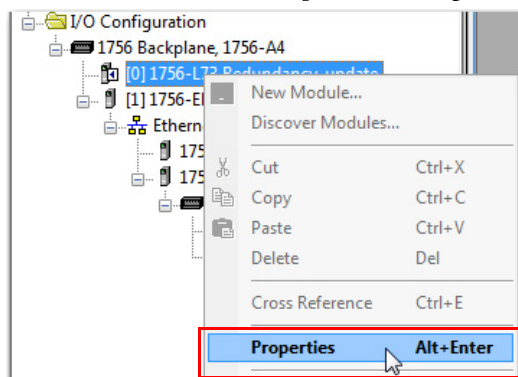

- Click the Redundancy tab and check Redundancy Enabled.

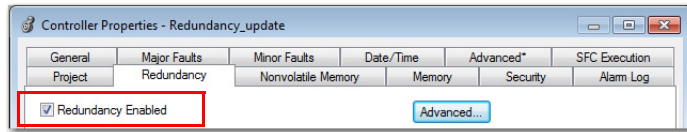

- If you are going to complete edits to your redundant controller while online, see these sections for information about the parameters available in the Advanced settings:
 - [Plan for Test Edits on page 127](#)
 - [Reserve Memory for Tags and Logic on page 131](#)
- Click the Advanced tab.

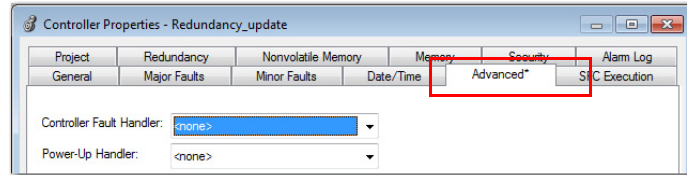

- Verify that Match Project to Controller is unchecked.

IMPORTANT

Do not use Match Project to Controller property with redundant controllers.

If you use the Match Project to Controller property available in the Advanced tab of the Controller Properties dialog box, you cannot go online with, download to, or upload from the new primary controller after a switchover. This is because the serial number of the new primary controller is not the same as the serial number of the old primary controller and the project cannot be matched to the newly switched to controller.

Verify that this option is not checked. →

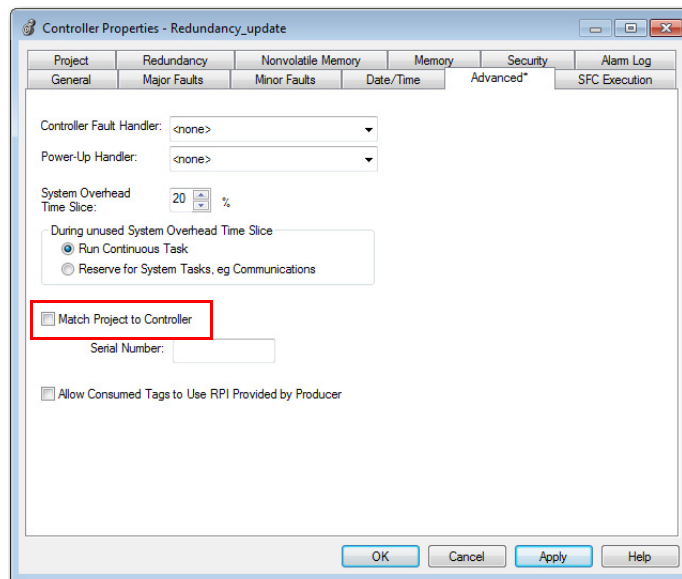

- Click Apply.
- Click OK.

You have completed the minimum configuration that is required for your redundant controllers.

Enable Time Synchronization

Time synchronization is not required for redundancy to function.

IMPORTANT Do not use CIP Sync Time Synchronization if it is not required, as it can increase crossload time and use up a significant amount of processing power in the 1756-RM2 module. You should only use CIP Sync Time Synchronization if required by an application element, such as Sequence of Event (SOE) module(s) being used in a remote rack.

If your application requires Time synchronization, then follow these steps.

1. At the Date/Time tab in Controller Properties, make sure that Enable Time Synchronization is checked.

Verify that this option is checked.

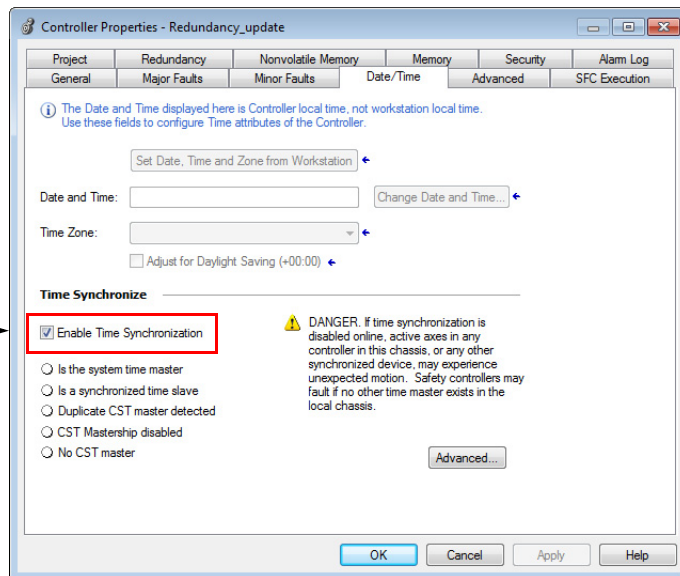

2. Click Apply.
3. Click OK.
4. Access the Module Properties dialog box for the Ethernet module.
5. At the General tab of the Module Properties dialog box of the Ethernet module, click Change.

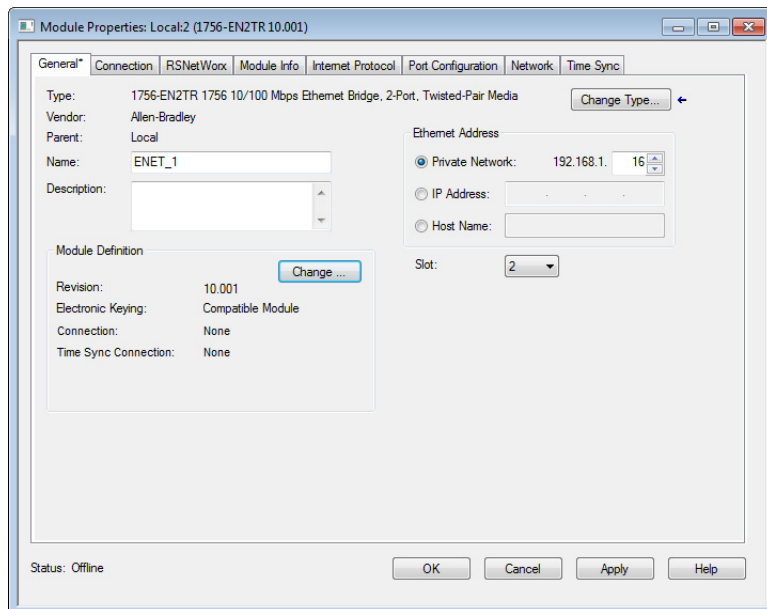

- In the Module Definition dialog box from the Time Sync connection pull-down menu, select Time Sync and Motion.

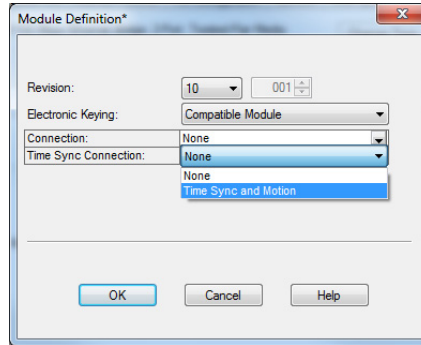

- Click OK to close the dialog box.
- At the warning dialog box, click Yes.
- Click Apply.
- Click OK to close the Module Properties dialog box.

Crossloads, Synchronization, and Switchovers

Crossloading and synchronization points are points where the primary controller transfers data to the secondary controller. Crossload and synchronization points keep the secondary controller ready to assume control in the event of a fault on the primary.

Before you begin programming your redundant controller, be aware of the impact of crossloads and synchronization on the execution of a program after a switchover. If you understand these concepts, it helps you to create programming that best meets the needs for your redundant application.

Continue reading the sections that follow for explanations of crossloads and synchronization and their relationship to switchovers and program execution.

Changing Crossload and Synchronization Settings

In the redundancy system, crossload and synchronization points for programs within the Studio 5000 Logix Designer® project are configurable. You can limit which programs data crossloading and synchronization follow. In many applications, changes to this setting can reduce the overall impact to the task scan time by reducing the number of times data is crossloaded.

If you reduce the number of crossload and synchronization points, the switchover time becomes longer. This increase in switchover time is because more programs can be rescanned after the switchover.

Synchronization is performed at the end of the last program in the program list of the task, regardless of the Synchronize Data after Execution setting for the program.

To change the synchronization setting of a program, open the Program Properties dialog box of the program and check or uncheck Synchronize Data after Execution.

Use this setting to change crossload and synchronization points.

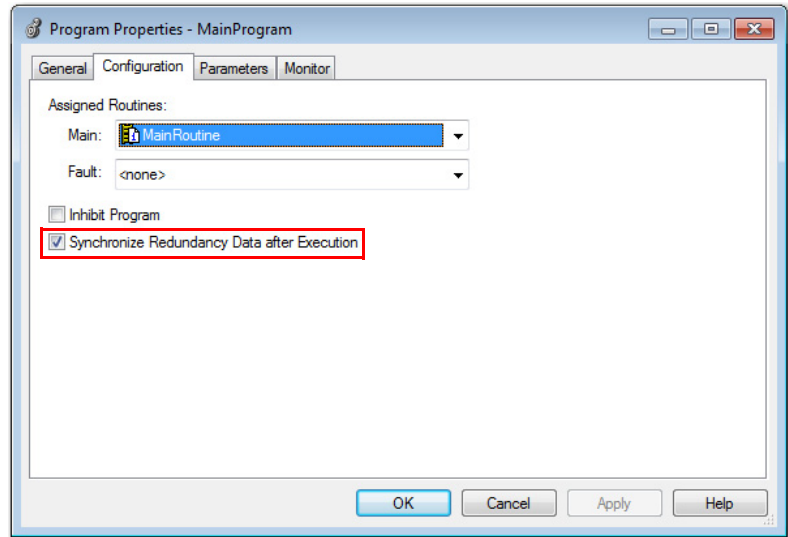

Default Crossload and Synchronization Settings

The default setting for a **program** in a redundant project is for a crossload to occur at the end of each program execution. However, for an **equipment phase**, the default is that the crossload not execute at the end of the phase.

Before you change the default crossload and synchronization settings, read the sections that follow so you have a complete understanding of the implications. For information about how to change the point in a task where a crossload occurs, see [Changing Crossload and Synchronization Settings on page 96](#).

Recommended Task Types

To avoid anomalies after a switchover occurs, we recommend that you use only one of these task configurations when programming your redundant controllers. Use either of the following:

- One continuous task
- Multiple periodic tasks, each with unique priorities and periods

Only the single highest-priority periodic task can ensure bumpless output switching on switchover. The sections that follow explain the impact of crossloads and synchronization after a switchover based on the task structure you use.

Continuous Task After Switchover

After a switchover occurs within a controller project that contains only a continuous task, the new primary begins executing at the last crossload and synchronization point. Depending on your crossload and synchronization setting, the program that the new primary controller begins with can be the following:

- The program that the switchover interrupted
- The program that immediately follows the last crossload and synchronization point

Continuous Task with Crossloads at Each Program End

This diagram demonstrates how programs set to crossload and synchronize at each program-end are executed after a switchover. As is shown, the new primary controller begins executing at the beginning of the program that the switchover interrupted. This process is the switchover execution that occurs if you use the default crossload and synchronization setting for a program.

Figure 25 - Program Execution After a Switchover (Crossload After each Program)

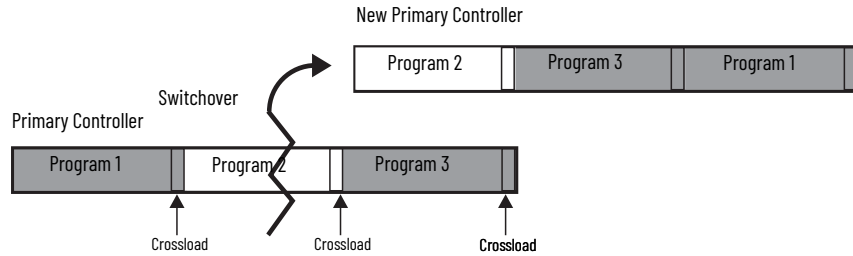

Continuous Task with Varying Crossloads at Program End

This diagram demonstrates how programs set to crossload and synchronize at various intervals are executed after a switchover. As is shown, the new primary controller begins executing the program that follows the last crossload and synchronization point.

Figure 26 - Program Execution After a Switchover (no Crossload After each Program)

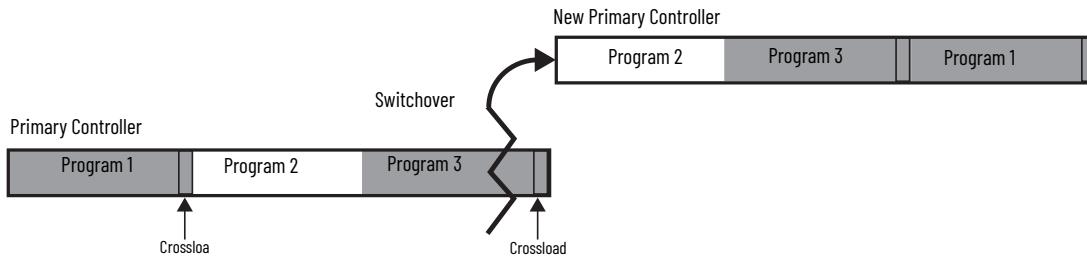

For information about how to change the point in a task where a crossload occurs, see [Changing Crossload and Synchronization Settings](#) on page 96.

Multiple Periodic Tasks



ATTENTION: If you use multiple periodic tasks, program all crucial outputs within the highest-priority task. Failure to program outputs in the highest-priority task can result in outputs changing state if a switchover occurs.

In a project where multiple periodic tasks are used, the point where program execution begins after a switchover depends on the following:

- Crossload and synchronization settings
- Task priority settings

As with the continuous task, the controller begins executing at the program that follows the last crossload and synchronization point.

In addition, a higher priority task can interrupt a lower priority task. If a switchover occurs during or just after the higher priority task executes and the lower priority task has not been completed, then the lower priority task and programs are executed from the point at which the last crossload occurred.

This diagram demonstrates how tasks at different priorities execute if a switchover occurs while a lower priority task is executing. The crossload and synchronization points in this example are set to occur only at the end of the last program within the tasks. The points are not set to occur at the end of each program.

Figure 27 - Normal Periodic Task Execution (no switchover)

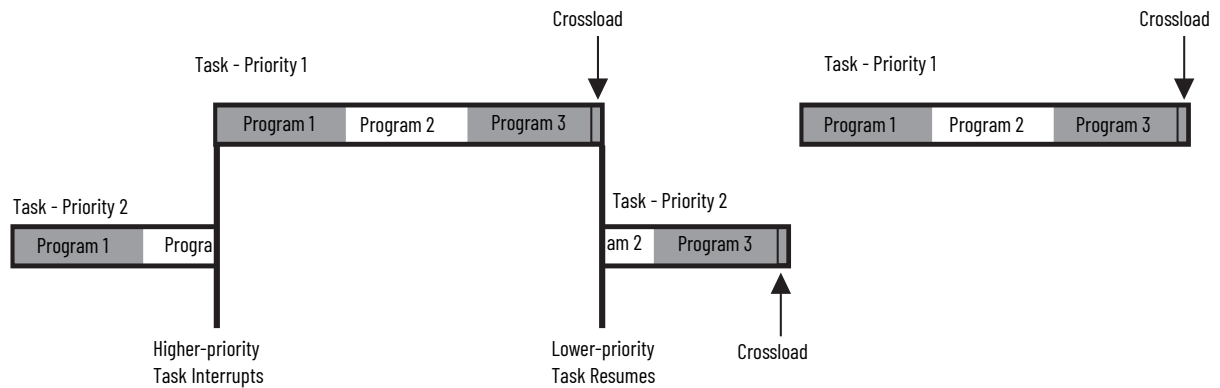

The following diagram shows a lower priority task that has not been completed and a switchover occurs. The lower priority task and programs are executed from the beginning of the program where the switchover occurred. This result is because the program uses the default configuration and crossloads and synchronization points occur at the end of each program.

Figure 28 - Periodic Task Execution After Switchover When Configured to Crossload After Programs

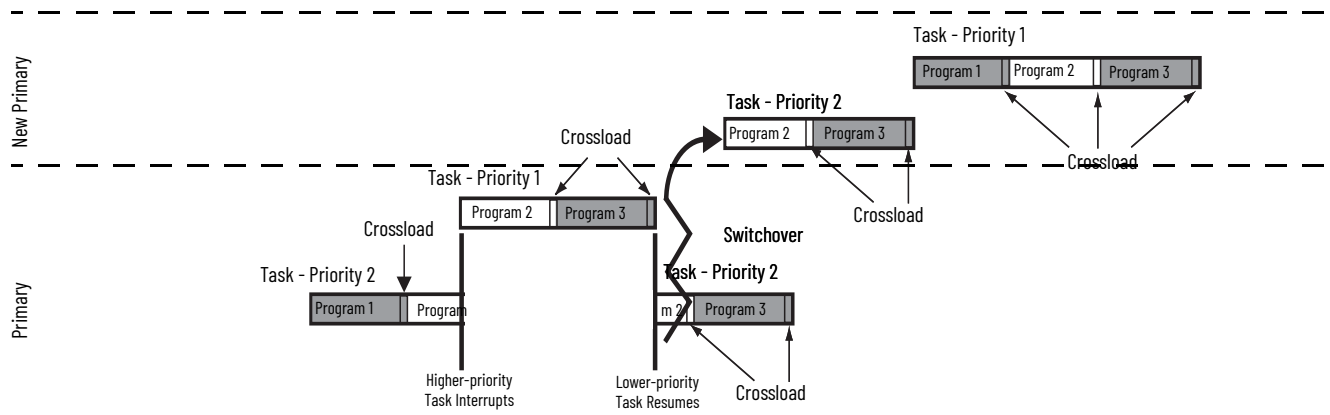

The following diagram shows a lower priority task that has not been completed and a switchover occurs. The lower priority task and programs are executed from the beginning and not at the program where the switchover occurred. This result is because the crossloads and synchronization points were not configured to occur at the end of each program.

Figure 29 - Periodic Task Execution After Switchover When Configured Not to Crossload After Programs

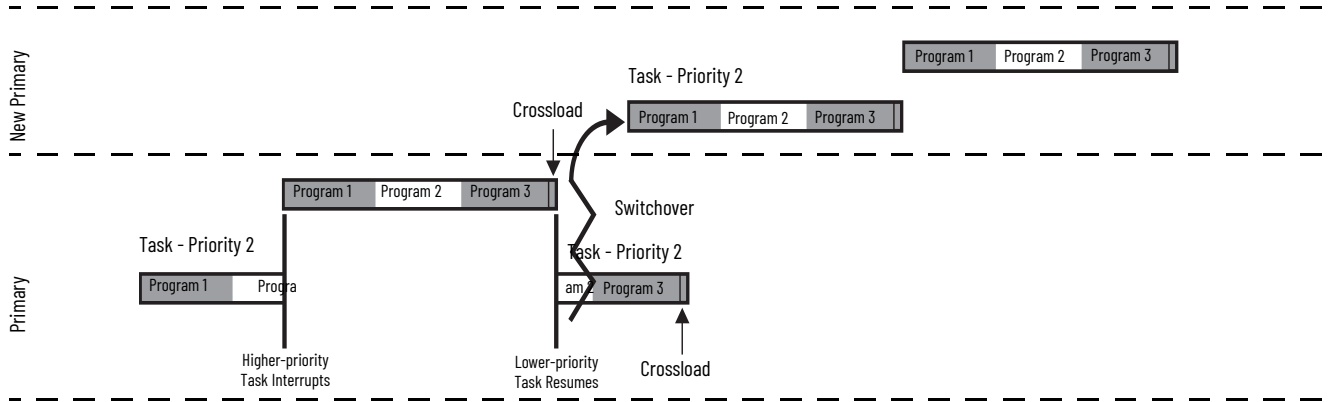

For more information about programs and tasks with controllers, see the Logix 5000 Controllers Tasks, Programs, and Routines Programming Manual, publication [1756-PM005](#).

Crossloads and Scan Time

It is important to plan for controller crossloads because the length of the crossloads affects the scan time of your program. A crossload is a transfer of data from the primary controller to the secondary controller. The crossload can occur at the end of each program or at the end of the last program in a task.

The scan time of your program or phase is a total of the program execution time and the crossload time. The following diagram demonstrates this concept.

Figure 30 - Crossload and Scan Time

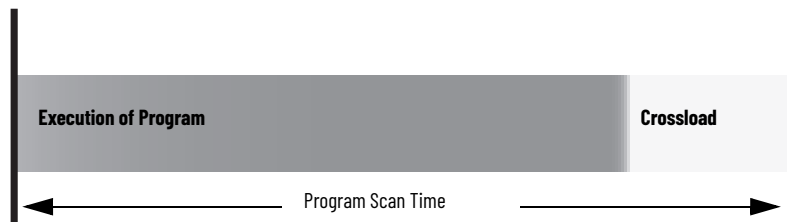

Estimate the Crossload Time

The amount of time that is required for a crossload is primarily dependent upon the amount of data being crossloaded. During a crossload, any tag that has been written to during the program execution is crossloaded. Even if a tag has not changed, but has been rewritten during the program execution, it is crossloaded.

The crossload requires time to transfer tag value changes. The crossload also requires a small amount of overhead time to communicate information about the program being executed