

1784-KTx
Communication
Interface Card
(Cat. Nos. 1784-KTX,
-KTXD, and -KTS)

User Manual

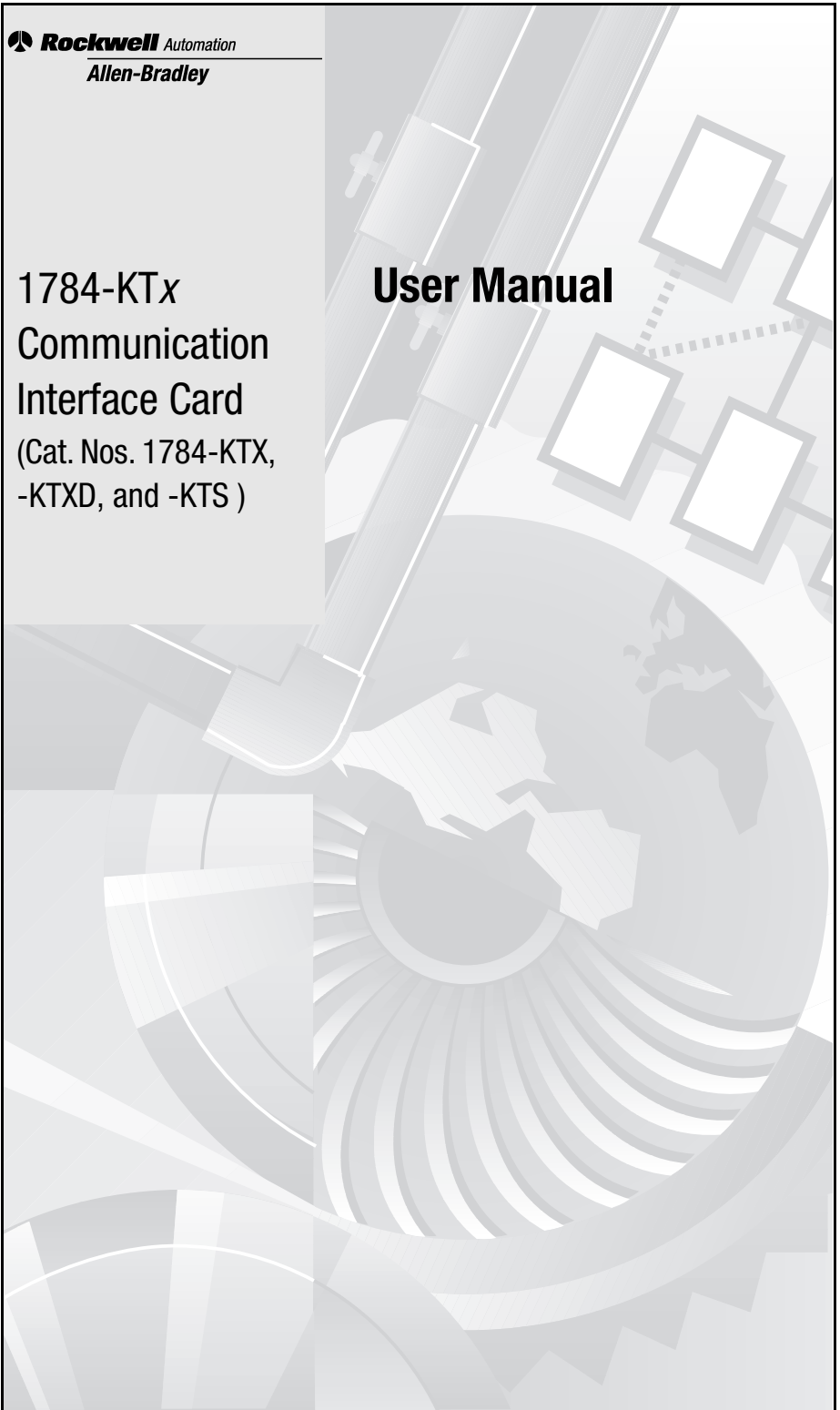

Important User Information

Because of the variety of uses for the products described in this publication, those responsible for the application and use of this control equipment must satisfy themselves that all necessary steps have been taken to assure that each application and use meets all performance and safety requirements, including any applicable laws, regulations, codes and standards.

The illustrations, charts, sample programs and layout examples shown in this guide are intended solely for purposes of example. Since there are many variables and requirements associated with any particular installation, Allen-Bradley does not assume responsibility or liability (to include intellectual property liability) for actual use based upon the examples shown in this publication.

Allen-Bradley publication SGI-1.1, *Safety Guidelines for the Application, Installation and Maintenance of Solid-State Control* (available from your local Allen-Bradley office), describes some important differences between solid-state equipment and electromechanical devices that should be taken into consideration when applying products such as those described in this publication.

Reproduction of the contents of this copyrighted publication, in whole or part, without written permission of Rockwell Automation, is prohibited.

Throughout this manual we use notes to make you aware of safety considerations:



ATTENTION: Identifies information about practices or circumstances that can lead to personal injury or death, property damage or economic loss

Attention statements help you to:

- identify a hazard
- avoid a hazard
- recognize the consequences

Important: Identifies information that is critical for successful application and understanding of the product.

Allen-Bradley is a trademark of Rockwell Automation.

Adherence to European Union Directive Compliance

If this product or package is marked with the **CE** mark, the product complies with the following European Union Directives:

Installation Requirements: If this product is installed within the European Union or EEA regions, the following regulations apply.

EMC Directive

This product is tested to meet Council Directive 89/ 336/EEC Electromagnetic Compatibility (EMC) using a technical construction file and the following standards, in whole or in part:

- EN 50081- 2 EMC – Generic Emission Standard, Part 2 – Industrial Environment
- EN 50082- 2 EMC – Generic Immunity Standard, Part 2 – Industrial Environment

The product described in this manual is intended for use in an industrial environment.

Low Voltage Directive

This product is tested to meet Council Directive 73/ 23/EEC Low Voltage, by applying the safety requirements of EN 61131–2 Programmable Controllers, Part 2 – Equipment Requirements and Tests.

For specific information required by EN 61131-2, see the appropriate sections in this publication, as well as the following Allen- Bradley publications:

- Industrial Automation Wiring and Grounding Guidelines, publication 1770- 4.1
- Guidelines for Handling Lithium Batteries, publication AG- 5.4
- Automation Systems Catalog, publication B111

This equipment is classified as open equipment and must be installed (mounted) in an enclosure as a means of providing safety protection.

Table of Contents

Important User Information	ii
Adherence to European Union Directive Compliance	iii
EMC Directive	iii
Low Voltage Directive	iii

Preface

Contents of Your Order	P-1
If you ordered a 1784-KTS Interface Card	P-2
Handle the Card	P-2
Specifications	P-3
Conventions	P-3
Summary of Changes	P-4
Revision Bars	P-4
Worksheet Tables	P-5
Related Publications	P-5
Rockwell Software Supports KTx Cards	P-5

Chapter 1

Introduction to the 1784-KTx Communication Interface Cards

How the 1784-KTx Card Operates	1-2
What to Do Next	1-2

Chapter 2

Configure the Card Hardware

Select the Base Memory Address Location	2-1
Set the Card's Switches	2-6
Select the Interrupt Setting	2-7
About KTx Interrupts	2-7
New DH+ Specification - Link Baud Rate	2-11
What to Do Next	2-11

Chapter 3

Install the Card Inside the Computer

Before You Begin	3-1
The KTx Skirt Area	3-2
Access the Computer's Expansion Slots	3-3
E3 Jumper Sets Operating Mode	3-4
Insert the Card	3-5
What to Do Next	3-5

Chapter 4

Connect the Interface Card

1784-KTX Connections	4-1
1784-KTS Connections	4-2
1784-KTXD Connections	4-2
Before You Begin	4-3
Connect the 1784-KTx Card to DH+ Devices	4-4
Connect the Card to a Classic PLC-5 Processor	4-4
Connect the Card to an Enhanced PLC-5 Processor	4-6
Terminate the Last Node	4-7
Connect the Card to a Data Highway Plus Network	4-7
Evaluate 1784-KTx Card Connection Options	4-7
Connect the Card via a DH-485 Network	4-8
Connect the Card to an SLC 500 Processor	4-9
Terminate the Last Node	4-10
What to Do Next	4-10

Appendix A

Run the 1784-KTx Card Diagnostics for Windows NT

Install the Diagnostics	A-2
Run the 1784-KTx Diagnostics for Windows NT	A-12
When Do I Run Diagnostics?	A-12
Troubleshooting the KTx Card	A-12
Error Message	A-17
No KTx cards are detected	A-17
View the readme.txt file	A-18
Remove the Card's Diagnostics in Windows NT	A-19

Appendix B

Run the 1784-KTx Diagnostics for DOS

When Do I Run Diagnostics?	B-1
Troubleshooting the KTx Card	B-2
Install DOS Diagnostics to Your Hard Drive	B-3
Access Diagnostics	B-5
Start Diagnostics	B-7
Define a KTx Card to Test	B-8
Run M16 Tests	B-10
Test Your Computer	B-11
Test the KTx Card	B-13
Test the Dual Port	B-15
Print the Log File	B-20

Appendix C

Use the KTx Card with 6200 Software

KTx Card and 6200 Software for PLC-5 and PLC-5/250 Programmable Controllers	C-1
KTx Card and 6200 Software for PLC-2 Direct-connect and PLC-3 Direct-connect	C-1

To the Installer

Use this document to install and use the 1784-KTX, 1784-KTXD, and 1784-KTS Communication Interface Cards. This document introduces the cards and outlines these procedures.

Procedure:	Refer to:
configure the card	Chapter 2
install the card inside the computer	Chapter 3
connect the card to devices and networks	Chapter 4
run card diagnostics for Windows NT	Appendix A
run card diagnostics for DOS	Appendix B

In this document, we refer to the 1784-KTX, 1784-KTXD, and 1784-KTS cards collectively as “1784-KTx card” or KTx card.” When one card differs from the other, this document individually calls out the cards by name.

Contents of Your Order

With this package you should receive:

- one 1784-KTx communication interface card
- one 1784-KTx Communication Interface Card User Manual, publication 1784-6.5.22
- one 3 1/2” 1784-KTx Utility diskette containing the installation and diagnostic programs, and the README.TXT file
- one 3 1/2” 1784-KTx Diagnostics for Microsoft Windows NT diskette

If you are missing any of these pieces, contact your Allen-Bradley sales representative.

If you ordered a 1784-KTS Interface Card

The contents of your order will differ slightly from what is listed on page P-1 of the user manual. 1784-KTS customers **do not** receive the utility disk.

With the 1784-KTS package, you should receive:

- one 1784-KTS communication interface card
- one 1784-KTx Communication Interface Card User Manual, publication 1784-6.5.22

If you are missing either of these pieces, contact your Allen-Bradley/Rockwell Automation sales representative.

Handle the Card





ATTENTION: The NetLinx 1784-KTx card uses CMOS technology, which is highly sensitive to electrostatic discharge (ESD). ESD may be present whenever you are handling the card. Handling the card without any ESD protection can cause internal circuit damage that may not be apparent during installation or initial use.

Take these precautions to guard against ESD damage:

- Before handling the card touch a grounded object to discharge any built-static charge.
- Avoid touching the backplane connector or interface connector pins on the 1784-KTx card.
- If the card is not in use, store it in the anti-static plastic-molded clamshell in which it was shipped.

Specifications

The operation parameters describe the environment within the KTx slot. Refer to the documentation for your computer for environmental requirements. The KTx card should not exceed those specifications.

Operational slot temperature	0 to 60°C (32 to 140°F)
Non-operational slot temperature	-40 to 85°C (-40 to 185°F)
Relative humidity	5 - 95% without condensation
Vibration	10 - 60 Hz, constant 0.012 in displacement
Operational shock	30 G peak for 11 ± 1 ms
Non-operational shock	50 G peak for 11 ± 1 ms
Power dissipation (for the 1784-KTXD)	600 mA @ 5V dc 3.15 W 20 mA @ =12V dc 240 mW 20 mA @ -12V dc 240 mW
Agency Certification (when product or package is marked)	<ul style="list-style-type: none"> •  •  Marked for all applicable directives

Conventions

We use these conventions in this manual:

For Windows applications screen displays and prompts are shown as screen and button captures:

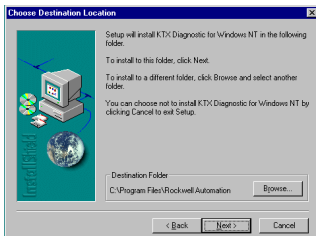

For DOS applications screen displays and prompts are shown as screen captures and text instructions.

- Press ENTER to continue with the installation
- **F10**
- Text that you type is shown as:

```
a:\install c:
```

Summary of Changes

Several additions and changes to the KTx card and software information have been made. The additions and changes to this manual include:

Information on:	Is in:
how to handle the card	Preface
Rockwell Software support	Preface
supported features	Chapter 1
diagnostics for Windows NT	Appendix A

Revision Bars

We use revision bars to call your attention to new or revised information. A revision bar appears as a thick black line on the outside edge of the page as indicated here.

Worksheet Tables

We recommend that you make one copy of **each** worksheet for **each** KTx card or channel (1784-KTXD). See Chapter 2.

Related Publications

Publication Title	Pub. No.
1784-KTx Scanner Reference Manual	1784-6.5.20
1784-KTx Dual-port Reference Manual	1784-6.5.21
1784-CP12 Cable Packing Data	1784-2.41
1784-CP13 Cable Packing Data	1784-2.44
1784-CP14 Cable Packing Data	1784-2.45
1784-CP15 Cable Packing Data	1784-2.43
1784-CP16 Cable Packing Data	1784-2.42
Data Highway/Data Highway Plus/Data Highway II/ Data Highway-485 Cable Installation Manual	1770-6.2.2

Rockwell Software Supports KTx Cards

Technical Support	Access at
Internet Web Site	www.ab.com - for non-registered members www.ab.com/mem/technotes/techmain.html - registered members
Autofax System	440.646.5436 - requires a touch-tone telephone
Rockwell Software Customer Support	440.646.5800 - For post-sales support and information on which Rockwell Software products support the KTx card.

Introduction to the 1784-KTx Communication Interface Cards

Your 1784-KTx communication interface card (cat. nos. 1784-KTX, 1784-KTXD, and 1784-KTS) is an ISA half-sized card that must be inserted into a 16-bit ISA or EISA expansion slot.

Important: You *must not* place this card in an 8-bit expansion slot. Improper operation and damage to the card will result.

Table 1.A shows the 1784-KTx card features.

Table 1.A Features supported by KTx cards

KTx card catalog #:	# of channels:	Active node on these networks:	Acts as remote I/O scanner:	Supported by this Allen-Bradley software:
1784-KTX	1	DH+ or DH-485	yes	<ul style="list-style-type: none">• 1784-KTx Scanner Reference Set• 6200 Series⁽³⁾• INTERCHANGE™• AI• RS Logix5 and RSLogix 500 via RSLinx
		PLC-2 and PLC-3 direct-connect ⁽¹⁾		
1784-KTXD	2	DH+ and/or DH-485 ⁽²⁾	yes	
1784-KTS	1		yes	<ul style="list-style-type: none">• 1784-KTx Scanner Reference Set

⁽¹⁾ Available via 6200 Series software

⁽²⁾ Available only on channel 1

⁽³⁾ Available in version 4.5 or later

How the 1784-KTx Card Operates

The 1784-KTx and -KTXD cards:

- communicate with nodes on Data Highway networks, including PLC-2[®], PLC-3[®], and on Data Highway Plus networks, including PLC-5[®], and SLC 5/04 processors, and SLC 5/01[™], SLC5/02, and SLC 5/03 processors (only via 1784KA5)
- communicate with SLC[™] processors on DH-485 networks
- act as a remote I/O scanner

The 1784-KTS card acts *only* as a remote I/O scanner.

The 1784-KTx performs data transmission, management, and local network diagnostics. The interface to the host processor is through a board-resident dual-port memory.

Allen-Bradley interface software (including RSLogix via RSLinx, AI, 6200, and INTERCHANGE) manages data transmission and reception through dual-port memory.

Remember to set the base memory address on the KTx card so that it does not interfere with selected addresses of other expansion cards in your computer. On dual-channel cards, set two addresses.

Important: Although the 1784-KTXD has two channels, you cannot use the card to directly bridge between two networks.

What to Do Next

Chapter 2 tells you how to configure the card hardware.

Configure the Card Hardware

Before you install the KTx card inside your computer, you must set the:

- base memory address - the card's physical addresses for the expansion memory area of the host processor's system memory, that enables the KTx card and the host computer to exchange data through the dual-port interface
- card's interrupt setting

Select the Base Memory Address Location

The host computer and the KTx card exchange data via a dual-port interface. The dual-port interface requires 4 Kbytes of memory (2 Kbytes for dual-port and 2 Kbytes for the rest of the interface). It begins at the specified base memory address location. You *must* select an area where there is at least a 4 Kbyte memory block available. If you have MS-DOS 6.0 or later, use the memory option in Microsoft Diagnostics (MSD) to identify available memory.

The 1784-KTx cards come set to memory address(es):

Catalog Number	Channel	Address
1784-KTS	1	D700:
1784-KTX	1	D700:
1784-KTXD	1	D700:
	2	D600:



ATTENTION: If you have a two-channel card, you must set the base addresses to different values—each channel must have a unique address. *Setting the base addresses to the same address can damage the KTx card.* If another card or channel is already using a channel's default memory address, you must pick a new address for the channel. Each channel on each card must have a separate and unique address.

Important: When selecting configuration settings, check for conflicts with other interface cards and system memory. If there is a conflict, the system will not operate properly. To avoid the conflict, you must change the base address of the channel via rotary switch settings to an open memory address.

Important: If you have a 386, 486, or Pentium host computer, you must find a way to disable caching and shadow memory for at least the 4K of memory space occupied by the KTx. This can usually be accomplished through your CMOS set-up program or memory manager, and *must* be done before running application with the KTx card.

To configure the base memory address, you turn rotary switches on the 1784-KTx card.

1. Determine addresses for the channel(s) on your KTx card.
 - A. Use Table 2.A on page 2-3 to determine the recommended memory address settings for your Allen-Bradley products.
 - B. Use Table 2.B on page 2-4 to determine which addresses are available for the KTx card channel(s).

Table 2.A Recommended memory address settings

Equipment	Channel #	Recommended Memory Location
1784-T35	1	CB00:
	2	CC00:
1784-T50	1	C300:
	2	C400:
T53 Industrial Programming Terminal	1	D700:
	2	D600:
T60 Industrial Workstations	1	D300:, D700:, or DB00:
	2	D200:, D600:, or DA00:
6180 Workstations	1	DD00:
	2	DC00:
6181 Workstations	1	DD00:
	2	DC00:
6155 Workstations	1	D700:
	2	D600:

Important: Verify within the 6155 workstations bios that any memory shadowing is disabled to prevent conflict with the dual port memory of the KTx.

Table 2.B System Memory Allocation

System Memory Address:	Typical PC Assignments:	Your System:	
0000:0000-07000:FFFF	521 Read/Write Memory on System Board		
8000:0000-09000:FFFF	128K Read/Write Memory Expansion in I/O Channel		
A000:0000-C700:0FFF	Video Buffer		
C800:0000-	Expansion Card Area (Area Available for KTx Memory Addresses)		
CF00:0000-			
D300:0000-		<i>White areas are available for KTx card</i>	
D700:0000-			
E000:0000-F000:FFFF	128K ROM Reserved on System Board		
10000:0000-FF000:FFFF	Unavailable for KTx		

2. Record your selection(s) in Table 2.C on page 2-5.

Remember that switches 1 and 3 represent the high order digits and that switches 2 and 4 represent the low order digits.

For example:

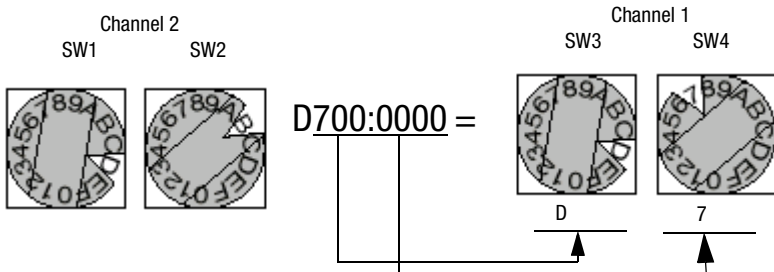



Table 2.C Address Selections

Record the base memory address for the 1784-KTx card's channel 1:

Card: _____

Slot number _____

Using default address: Yes No

Channel 1

If no, new memory address: _____



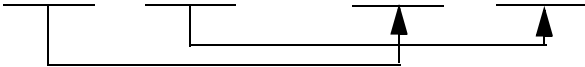

Record the base memory address for the 1784-KTx card's channel 2:

Card: _____

Slot number _____

Using default address: Yes No

Channel 2

If no, new memory address: _____

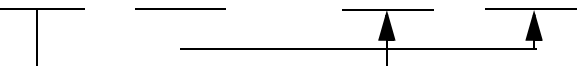

Set the Card's Switches



ATTENTION: When you set the switches, be certain to avoid touching other components on the card.

To set the card's switches, follow these steps:

1. Follow the card handling instructions on page P-2.
2. Remove the 1784-KTx card from the anti-static clamshell.
3. Use the decision table below.

If you need to:	Then:
use the card's default memory address settings shown on page 2-1	go to the next section, Selecting the Interrupt Setting
set a new base memory address	turn the knobs to reflect the address(es) from Table 2.C on page 2-5

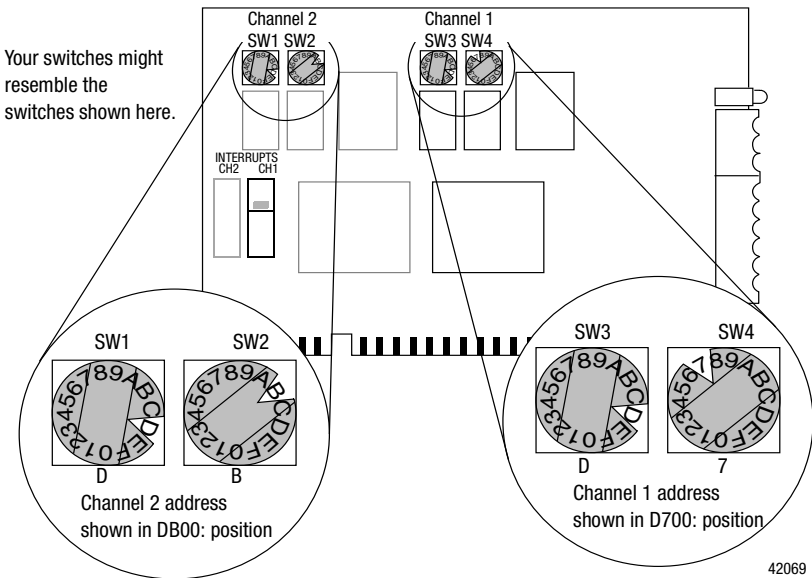

42069

Select the Interrupt Setting

Important: If you need to use the KTx as a remote I/O scanner within a SoftLogix5 system, you must set an interrupt for the scanner channel

Important: When selecting configuration settings, check for conflicts with other interface cards and system memory. If there is a conflict, the system will not operate properly. To avoid the conflict, select a unique interrupt setting for each channel. If another card is already using a channel's default interrupt, you *must* pick a new interrupt for the channel.

About KTx Interrupts

The 1784-KTx cards are set to these interrupt(s):

Catalog Number	Channel	Interrupt
1784-KTS	1	no interrupt
1784-KTX	1	
1784-KTXD	1	
	2	

If you are:	Then:
using the card's default interrupt settings, i.e., no interrupt	go to the next section, Installing the Card Inside the Computer
setting new interrupts	move the jumper to the new interrupt location(s) (as entered on Table 2.E, page 2-10)

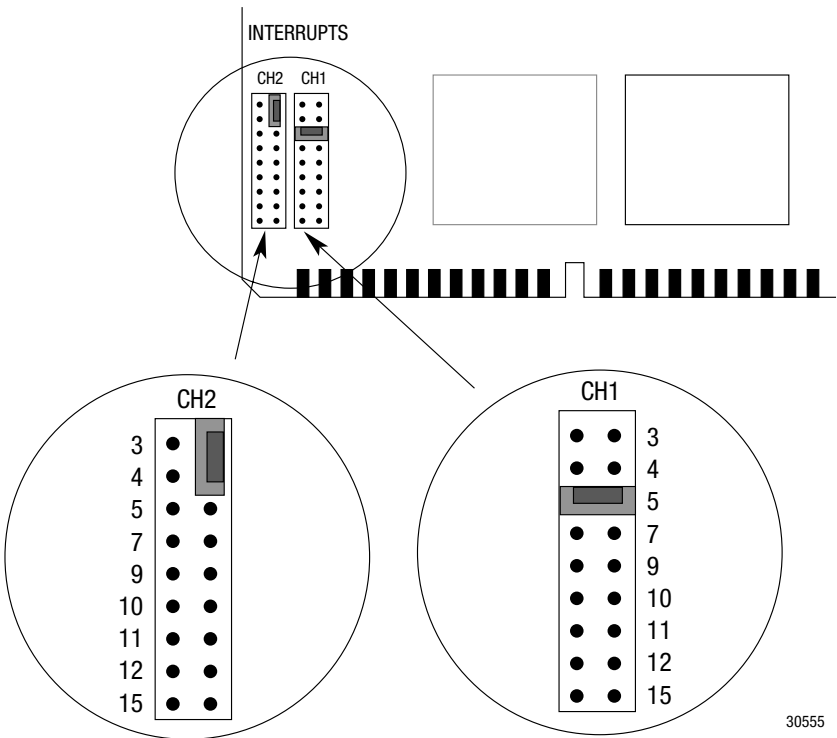

Important: If you are using the “no interrupt” setting, you must place the jumper vertically over two pins on the right-side row as shown. This way you can save the jumper for future use. Placing the jumper on the left-side row will cause interrupt problems on the motherboard.

1. Determine the interrupt(s) for the channel(s) on your KTx card. Use Table 2.D to determine which interrupts are available for the KTx card channel(s).

Important: If you are using the KTx for remote I/O scanner emulation, you must set an interrupt for the scanner channel.

Table 2.D Host Computer IRQ Assignments

Interrupts	Assignments	Your System
IRQ0	Timer Output	
IRQ1	Keyboard (Output Buffer Full)	
IRQ2	Interrupt from Controller 2	
IRQ3	Serial Port 2	
IRQ4	Serial Port 1	
IRQ5	Parallel Port 2	
IRQ6	Diskette Controller	
IRQ7	Parallel Port 1	
IRQ8	Real-time Clock Interrupt	
IRQ9	Software Redirected to INT 0AH (IRQ2)	
IRQ10	Available	
IRQ11		
IRQ12		
IRQ13	Co-processor	
IRQ14	Fixed Disk Controller	
IRQ15	Available	

Note: White areas are available for KTx card if you disable the function within the PC's BIOS.

2. Record your selection(s) in Table 2.E

Table 2.E Jumper Settings

Important: If you are using the “no interrupt” setting, you must place the jumper vertically over two pins on the right-side row as show on page 2-7. This way you can save the jumper for future use. Placing the jumper on the left-side row will cause interrupt problems on the motherboard.

Record the interrupt setting for the 1784-KTx card's channel 1:

Card: _____

Slot number _____

Using default address: Yes No

If no, new interrupt: _____

CH1

	3
	4
	5
	7
	9
	10
	11
	12
	15

Record the interrupt setting for the 1784-KTx card's channel 2:

Card: _____

Slot number _____

Using default address: Yes No

If no, new interrupt: _____

CH2

	3
	4
	5
	7
	9
	10
	11
	12
	15

New DH+™ Specification - Link Baud Rate

Allen-Bradley has added 230k baud rate enhancements to the DH+™ firmware of the KTx.

Note this update to the KTx dualport memory map for DH+, which is documented in publication 1784-6.5.21

:0007h	Link Baud Rate	INI	FCh = 57.6 Kbaud FEh = 230.4 Kbaud	R.....W	Host writes a valid value (KTx baud rate) to byte:00007h. KTx reads at start-up.
--------	----------------	-----	---------------------------------------	---------	--

Important: Check the product documentation for your RSI communication software to see if the product supports 230k baud rate.

What to Do Next

Chapter 3 tells you how to install the card inside your computer.

Install the Card Inside the Computer

You've set the memory addresses and interrupts; you're ready to place the KTx card inside your computer.

Before You Begin

Consider these points before you begin:

- Do I know everything I need to know to accomplish my task?
- Do I have the proper tools at hand?
- Do I understand where I can and can't put this card?

On the Right Track?

Be certain that you know how to:

- configure the computer's options *before* you install the 1784-KTx
- install hardware into your computer's expansion slots

Consult your computer's documentation for specific information.

Where's Your Screwdriver?

You need one of these tools to remove the cover from your central processing unit (CPU):

- Phillips-head screwdriver
- flat-head screwdriver

The KTx Skirt Area

Important: As shown in Figure 3.1, placing the card in certain computers may cause mechanical interference with improperly placed components on the motherboard of the computer. Be certain to position the card away from components that can touch the KTx's skirt area.

Figure 3.1 How Mechanical Interference Occurs

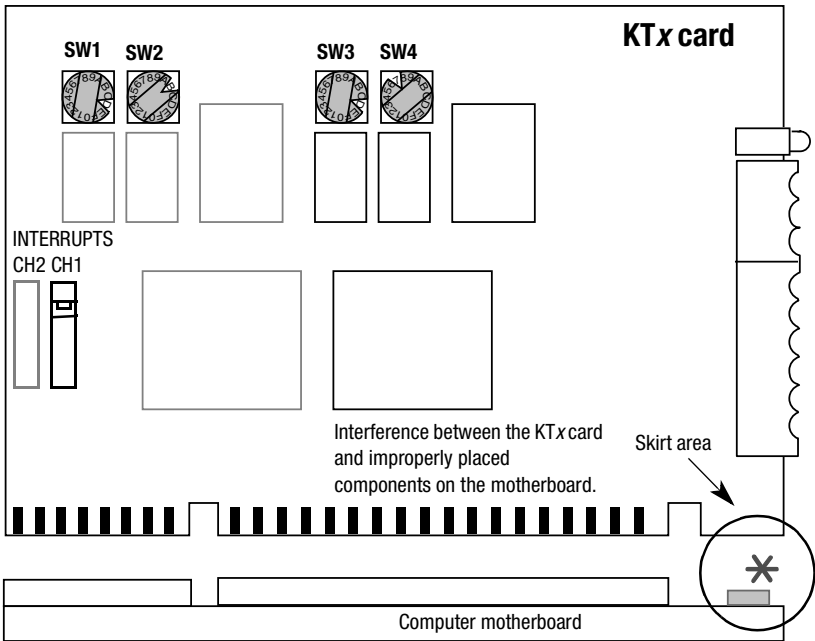

42073

Access the Computer's Expansion Slots

To install the KTx card, you must have access to the computer's bus. Refer to your computer's hardware manual for instructions about how to:

1. Shut down and halt the host computer.
2. Turn off power to the computer.

Important: If you *disconnect* the ac power from the computer, you lose the chassis ground. Electrostatic damage (ESD) protection is lost.

3. Remove the computer's CPU cover (according to the manufacturer's instructions).
4. Select a vacant 16-bit ISA or EISA expansion slot.

Important: The 1784-KTx will function only in a 16-bit ISA or EISA expansion slot.

5. Remove the rear bracket slot's expansion cover by loosening the screw on the back of the computer.

E3 Jumper Sets Operating Mode

The E3 jumper sets the card to 8- or 16-bit mode.

Important: You must place the card in a 16-slot connector regardless of the chosen mode of operation. Eight-bit mode is included only as a fall-back in case of system issues with 16-bit operation; you should run the card in 16-bit mode.

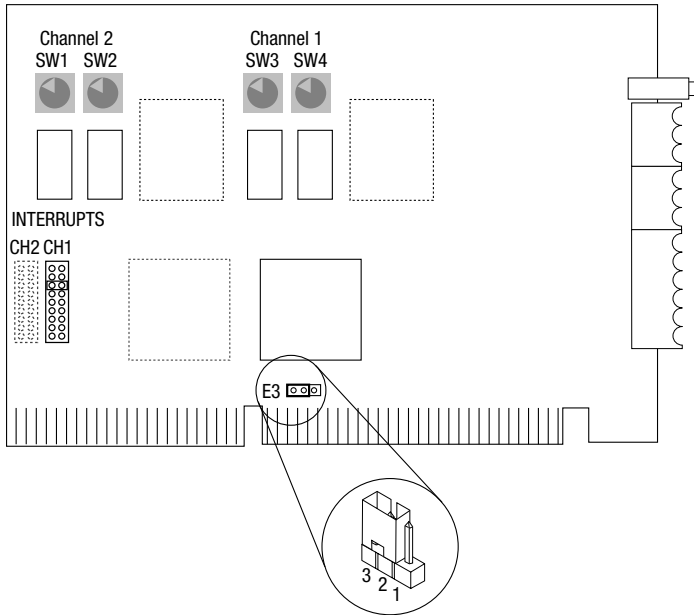

30142

To set this mode:	Jumper these pins:
16-bit*	pins 2 and 3, the two left-most pins
8-bit	pins 1 and 2, the two right-most pins

*Shipped from the factory in default 16-bit mode

Insert the Card

To insert the card inside the computer:

1. Follow the instructions on how to handle the card on page P-2.
2. Be certain that you have set correctly all of the switches and jumpers on the card. See Chapter 2.
3. Turn off power to the computer.

Important: If you *disconnect* the ac power from the computer, you lose the chassis ground. Electrostatic damage (ESD) protection is lost.

4. Loosen the expansion slot screw and remove shield outside retaining bracket (ORB),
5. Insert the KTx card into the edge connector and tighten the expansion slot screw on the KTx ORB.
6. Restore power to the computer.
7. Run the appropriate version (DOS or NT) of the KTx diagnostics from the appropriate disk *now*. For instructions on installing the Windows NT diagnostic see Appendix A and see Appendix B for the DOS diagnostic.
8. Activate the application software.
9. Be certain that the KTx settings are compatible with the application software program.

If it does not come up correctly, you may have to change the switch settings. When the unit comes up correctly, go to step 10.

10. Turn off power to the computer.
11. Replace CPU cover.

What to Do Next

Chapter 4 tells you how to connect the KTx card to various networks and devices.

Connect the Interface Card

You can connect the KTx card to these networks and devices:

- DH+ networks
 - classic PLC-5 processors
 - enhanced PLC-5 processors
 - SLC 5/04 processors
 - ControlLogix DH+/RIO
- DH-485 networks
 - selected SLC 500 processors
 - remote I/O networks acting a scanner

1784-KTX Connections

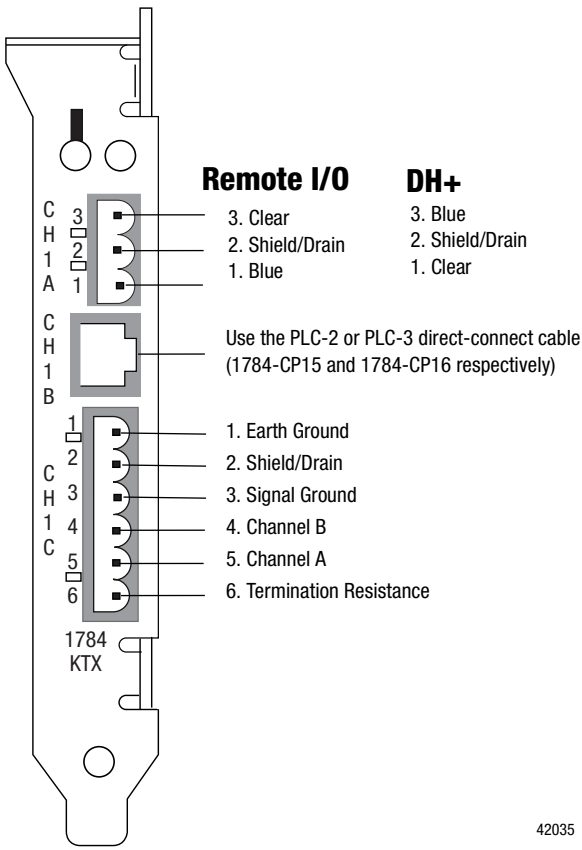

1784-KTS Connections

1784-KTXD Connections

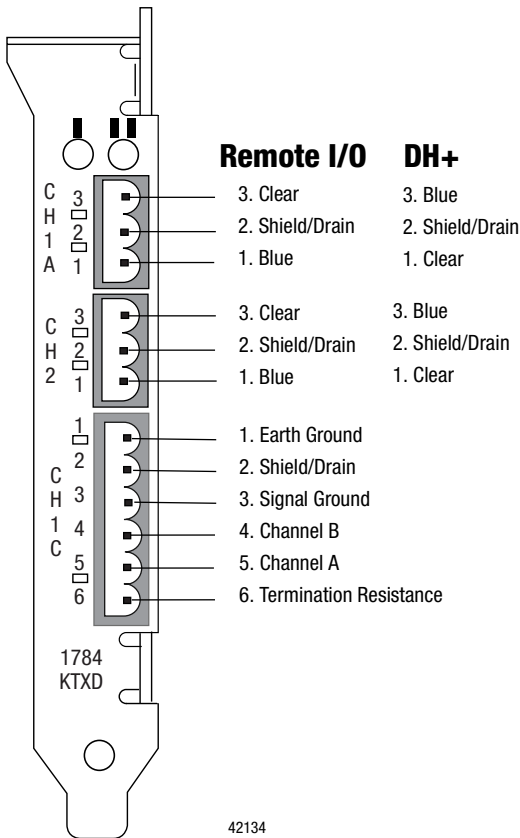

42134

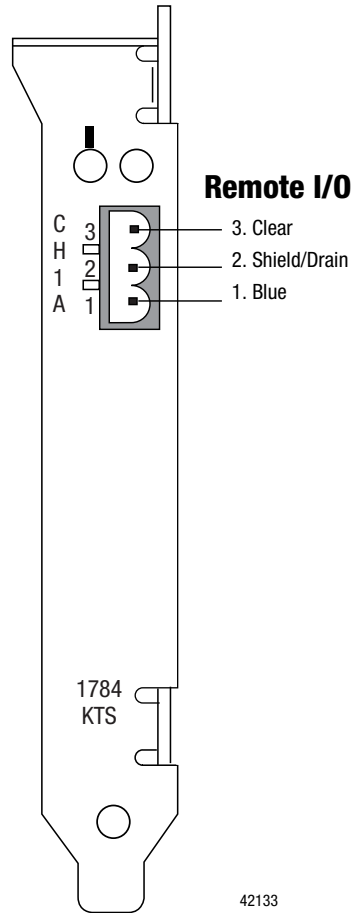

42133

Before You Begin

Before you make the connections, be certain that you have the correct cables. This table lists the cables for various programmable controllers and processors:

For:	Use cable with catalog number:
PLC-5/10, -5/12, -5/15, -5/25, -5/VME (6008-LTV) and PLC-5/250 classic programmable controllers	1784-CP12
PLC-5/11, -5/20, -5/30, -5/40, -5/60, -5/80, and -5/VME (1784-V40) enhanced programmable controllers SLC 5/04 processors	1784-CP13
SLC 500 processors	1784-CP14
PLC-2 direct connect	1784-CP15
PLC-3 direct connect	1784-CP-16
DH-485	BELDEN #9842 ⁽¹⁾ ⁽²⁾
remote I/O / DH+	1770-CD ⁽¹⁾ ⁽³⁾

⁽¹⁾ Cables used for construction of custom cables

⁽²⁾ Mating Connector: A-B PN 94199-06 or Phoenix Order No. 1849406

⁽³⁾ Mating Connector: A-B PN 941999-03 or Phoenix Order No. 1849396

For additional cable information, see these Allen-Bradley publications:

Publication:	Number:
1784-CP12 Cable Packing Data	1784-2.41
1784-CP13 Cable Packing Data	1784-2.44
1784-CP14 Cable Packing Data	1784-2.45
1784-CP15 Cable Packing Data	1784-2.43
1784-CP16 Cable Packing Data	1784-2.42

Connect the 1784-KTx Card to DH+ Devices

In your application, you may need to use the KTx card to communicate with a single device or multiple DH+ devices via a DH+ network. This section shows you how to connect to a classic or an enhanced PLC-5 processor.

Connect the Card to a Classic PLC-5 Processor

To connect the 1784-KTX or-KTXD card to a *classic* PLC-5 processor, follow these steps:

1. Turn off power to the computer.

Important: If you disconnect the ac power from the computer you loose the chassis ground. Electrostatic damage (ESD) protection is lost.

2. Connect the 3-pin Phoenix end of the CP12 cable to the KTx card.

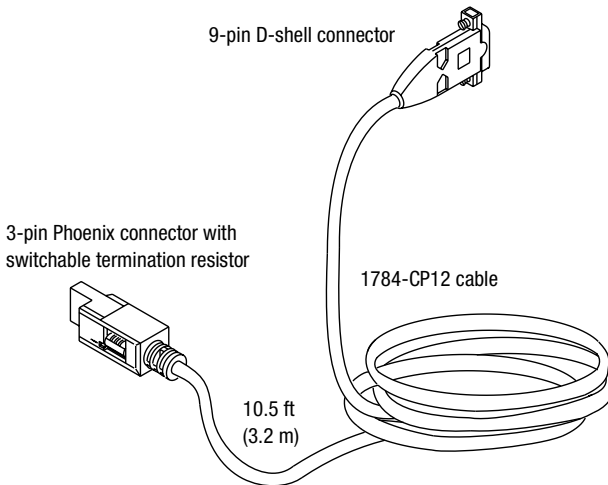

42135

3. Connect the 9-pin D-shell end directly to the 9-pin D-shell connector on the front of the classic PLC-5 processor.

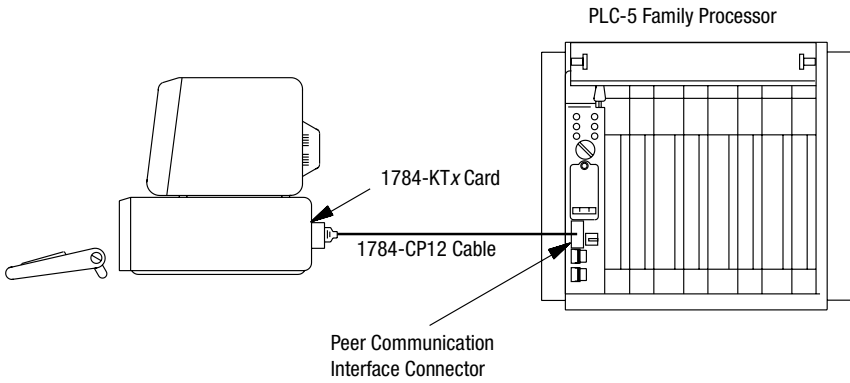

18341

4. Restore power to the computer.

Connect the Card to an Enhanced PLC-5 Processor

To connect the 1784-KTX or -KTXD card to an *enhanced* PLC-5 processor, use a 1784-CP12 cable and a 1784-CP7 adapter. Follow these steps:

1. Connect the 3-pin Phoenix end of the CP12 cable to the KTx card.
2. Connect the 9-pin D-shell connector to the CP7 adapter.
3. Connect the adapter to the connector on the front of the enhanced PLC-5 processor.

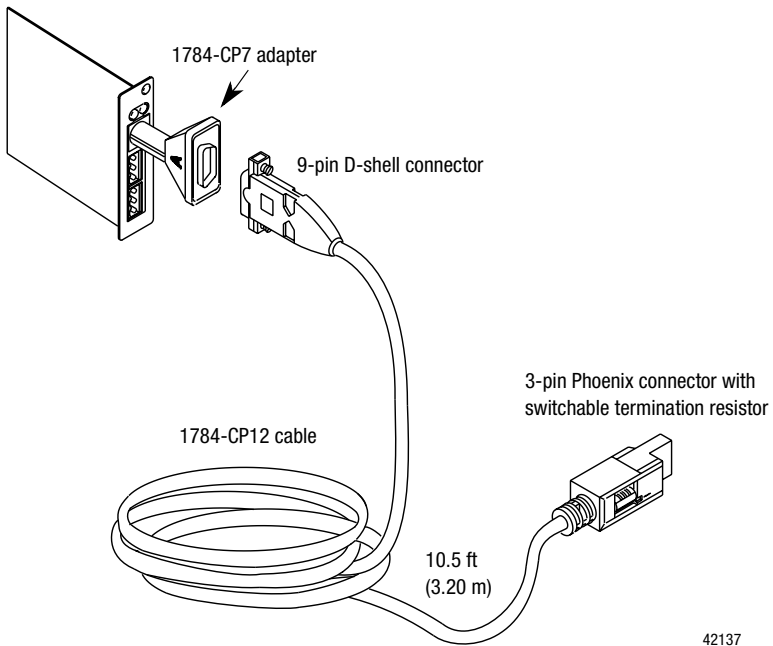

42137

For additional information about the 1784-CP7 adapter, refer to publication 1784-2.29, the CP7 Adapter Installation Data.

Terminate the Last Node

You must terminate both ends of your DH+ network. If the KT_x is the last physical node on your network, you must set the switch on the CP12 to terminate the link as shown below.

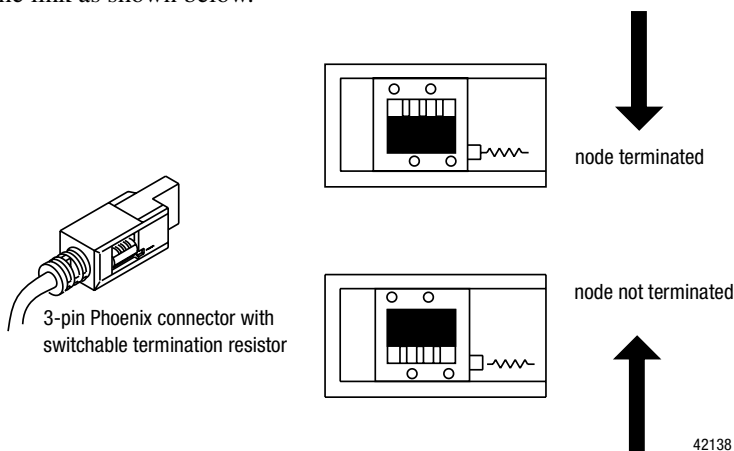

Connect the Card to a Data Highway Plus Network

To connect the 1784-KTx or -KTXD card to a Data Highway Plus network, use Allen-Bradley 1770-CD or approved cable to construct custom cable.

Important: You must terminate the last physical node of the network with a resistor of appropriate value.

Evaluate 1784-KTx Card Connection Options

In your application, you may need to use the 1784-KTx card to communicate with:

- multiple DH-485 stations (for example, SLC 5/0x programmable controllers) via the DH-485 network (page 4-8)
- a single SLC 500 via a point-to-point DH-485 link (page 4-9)

Figure 4.1 and Figure 4.2 illustrate these applications.

Connect the Card via a DH-485 Network

Figure 4.1 shows an example of a network consisting of three SLC 500 controllers and one programming station. This configuration requires the 1784-KTX or -KTXD card and three link couplers:

- An SLC 500 CPU is connected to each of the link couplers (1747-AIC) with a 1747-C11 cable.
- The 1784-KTX or -KTXD card is connected to the network at one of the link couplers, as shown in Figure 4.1.
- The communication cable consists of three segments of cable daisy-chained at each link coupler.

Figure 4.1 Communicate to multiple SLC 500s via the DH-485 network

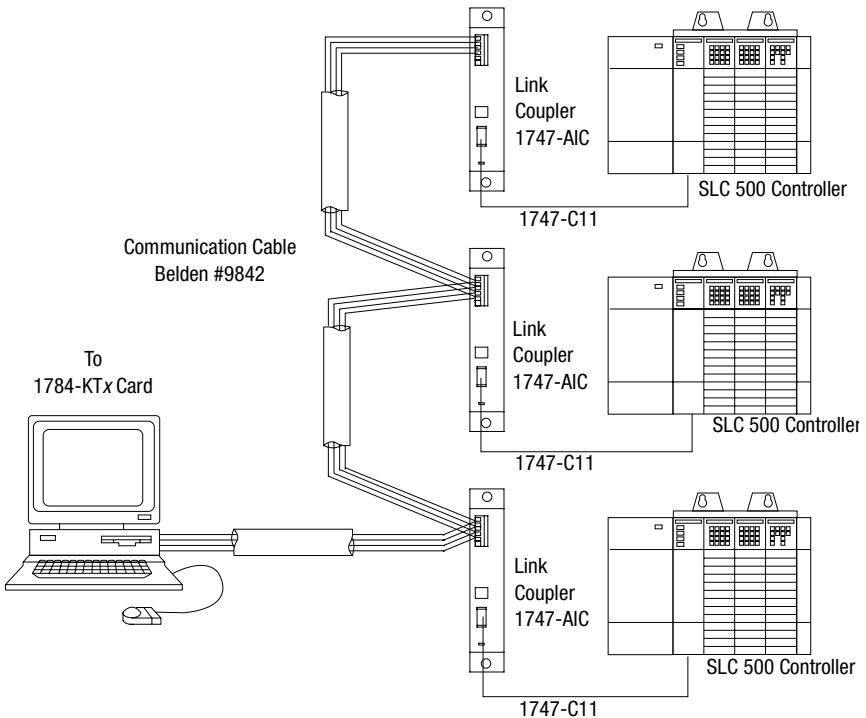

42139

Connect the Card to an SLC 500 Processor

Figure 4.2 shows an example of a point-to-point link consisting of an SLC 500 processor and a programming station. This configuration requires the 1784-KTX or -KTXD card and an SLC 500 processor. The SLC 500 CPU is connected directly to the 1784-KTX or -KTXD card with a 1784-CP14 cable, as shown.

Figure 4.2 Communicating to a single SLC 500 using a point-to-point DH-485 link

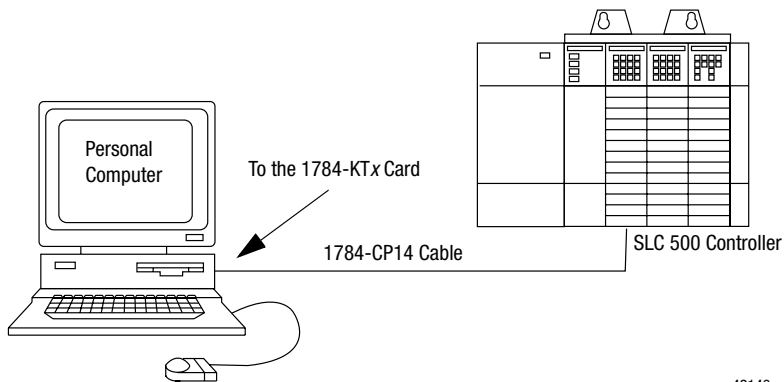

42140

To connect an SLC family processor to the KTx card, you:

1. Connect the termination resistor end of the CP14 cable to the KTx card.
2. Connect the RJ-45 connector directly to the phone-jack connector on the front of the SLC processor.

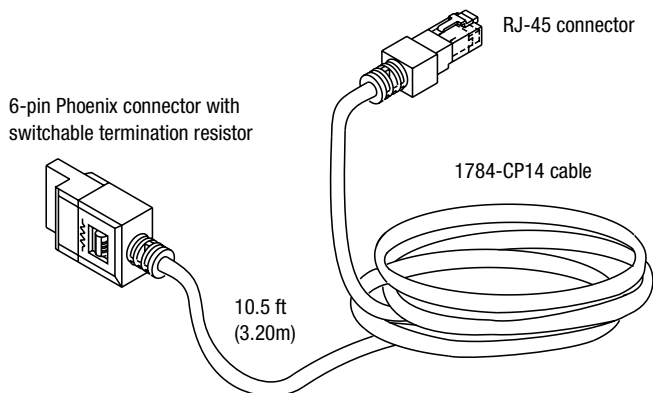

42141

Terminate the Last Node

You must terminate both ends of your DH+ network. If the KT_x is the last node on your network, you must set the switch on the CP14 to terminate the link as shown below.

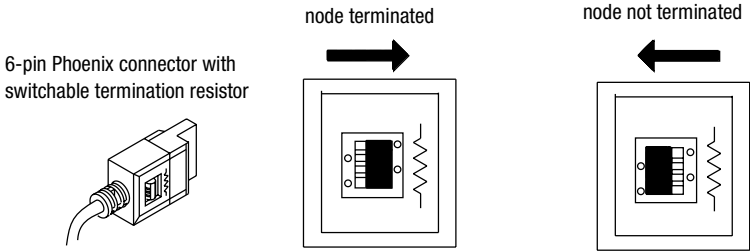

42142

Refer to publication 1770-6.2.2, Data Highway/Data Highway Plus/Data Highway II/Data Highway-485 Cable Installation Manual, for additional information about cable issues.

What to Do Next

If you have read each chapter, completed the worksheets, run diagnostics, and still have questions, please call Rockwell Automation Technical Support at 440.646.5800.

Run the 1784-KTx Card Diagnostics for Windows NT

Read this chapter to learn how to operate the 1784-KTx card on Windows NT. Read the following before you install your 1784-KTx card.

Important: The 1784-KTS card will not run the dual-port test. It will attempt to run and fail.

The Windows NT diagnostics support the 1784-KTX, -KTXD, and -KTS cards at all addresses. It also supports the 1784-PKTX, -PKTXD, and -PKTS cards but only if the cards jumper is set to memory addresses below 1 megabyte.

Install the Diagnostics

Be aware of the following important points before installing the Windows NT diagnostics for 1784-KTx card.

Important: Before you can install the diagnostics for the 1784-KTx card, you must be logged in as an administrator of the machine or have administrator privileges. Being an administrator gives you permission to install or make changes to the machine software. If you try to install the driver without being an administrator, you will get error messages and the diagnostics will not install.

- We recommend running Windows NT 4.0 with Service Pack 3 or later, but it is not required.

Follow the procedure below to install the 1784-KTx diagnostics for Windows NT.

1. Start the install process with your machine off.
2. Install the 1784-KTx card into your computer by following the card installation instructions in Chapter 3.

3. Turn your machine on and logon as an administrator.

Important: Remember, in order for the installation process to run correctly, you must have (administrator) privileges to install the software.

4. Insert the installation diskette into the floppy disk drive.

Important: We strongly recommend that you exit all Windows programs before running this utility. We cannot guarantee that data will not be lost.

5. Access the Run window by selecting:

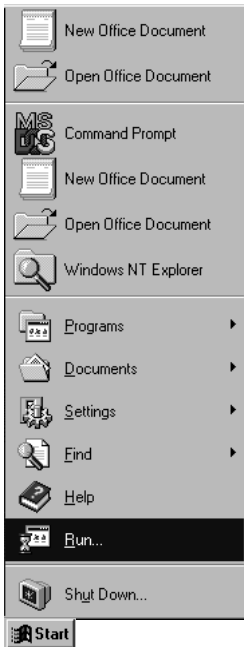

The Run dialog box appears.

6. Type the path `a:\setup.exe`.
Substitute `a:\` for the drive of your floppy disk, i.e `b:\`.

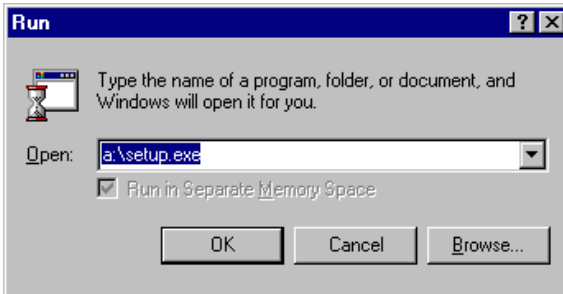

7. Click  .

Please wait until InstallShield is finished.

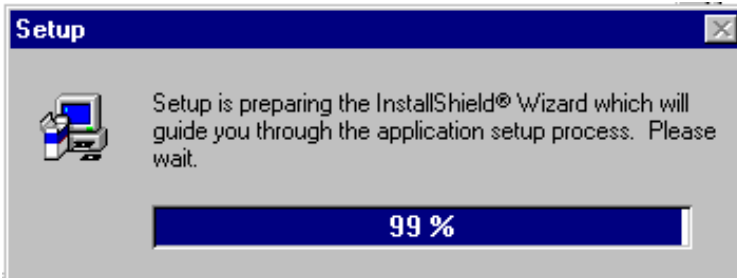

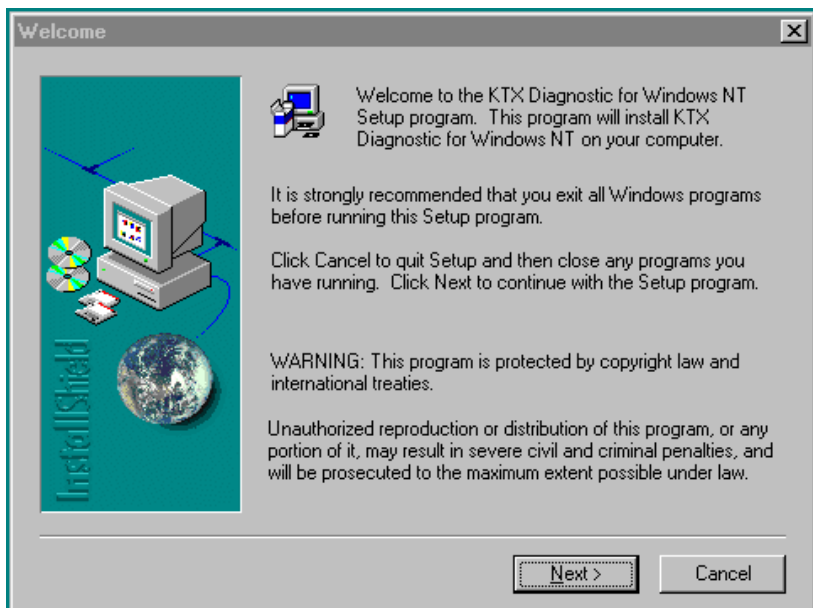

8. Read the information and decide either to continue or to cancel.

9. Click to continue with the install.

You see:

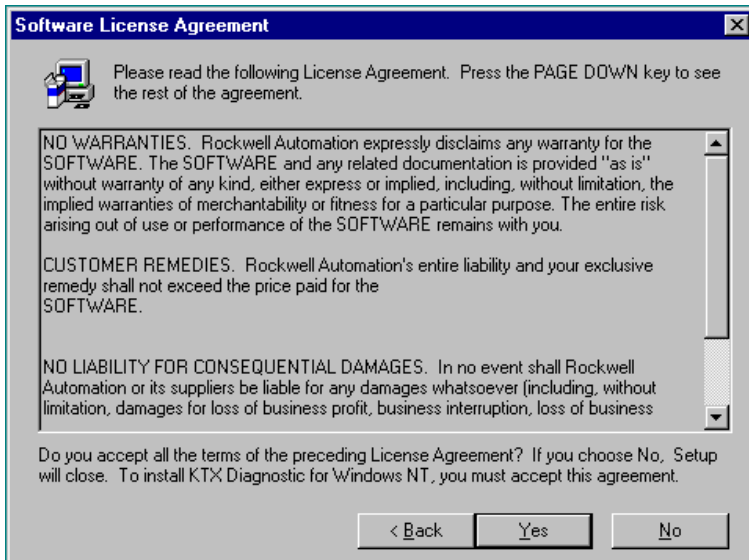

10. To accept agreement and continue, click .

You see:

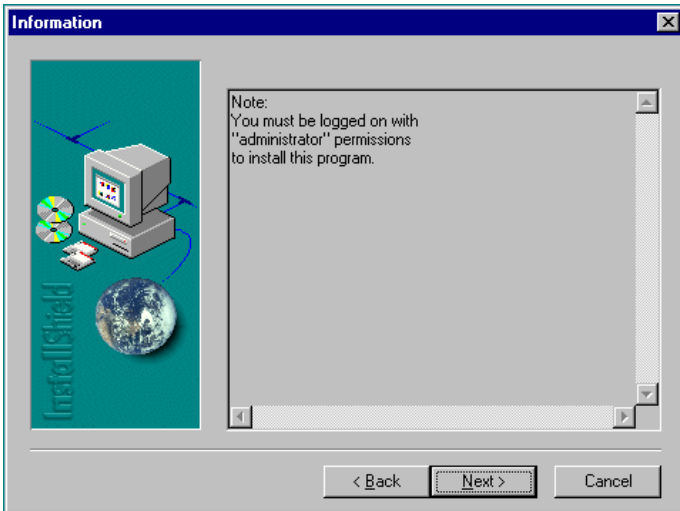

11. Click if you have administrator permissions.

If you don't know if you have administrator permissions, click and see if the install process continues and go to Step 10. If the process does not continue you don't have administrator permissions, contact your Systems Administrator.

12. Now you have the opportunity to choose the destination of the software.

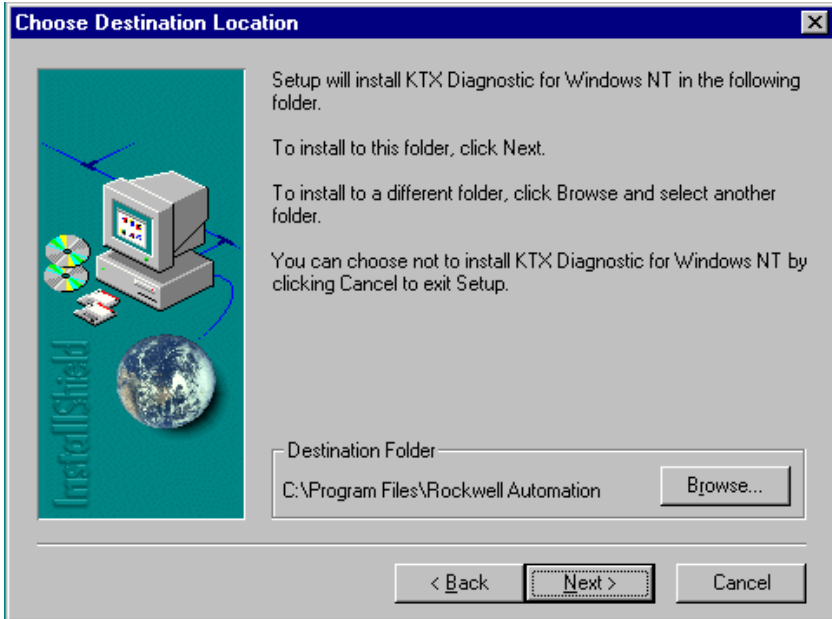

13. Click to accept the default location (recommended). If you would like to change the destination folder, click .

14. After you choose to select the default destination. Select a program folder. The default is displayed. If you choose not to use the default, click on the folder you created or assigned in the previous window.

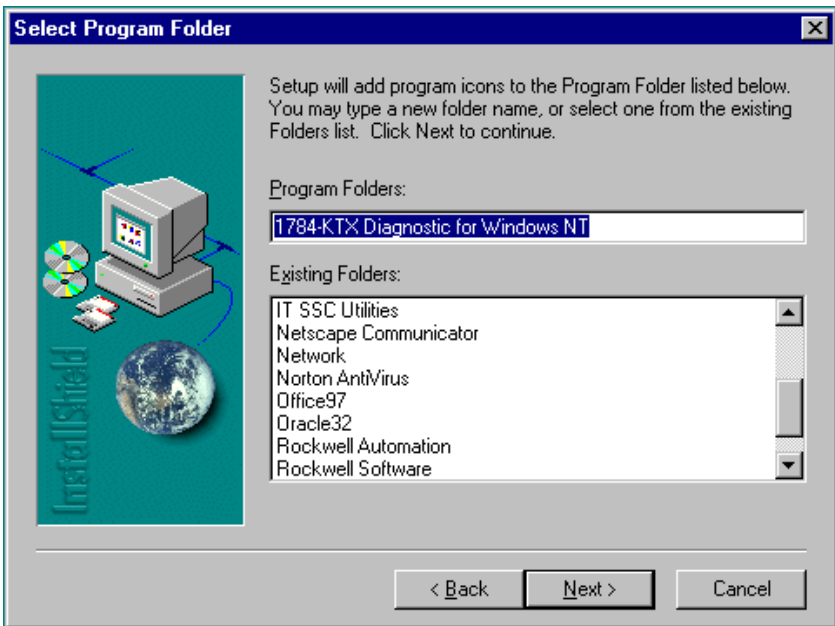

15. Click to accept the default.

The install process is very fast. You will see a couple small windows appear and disappear quickly. When the installation process is over you see:



and:



16. Click to end the install process.

You see:

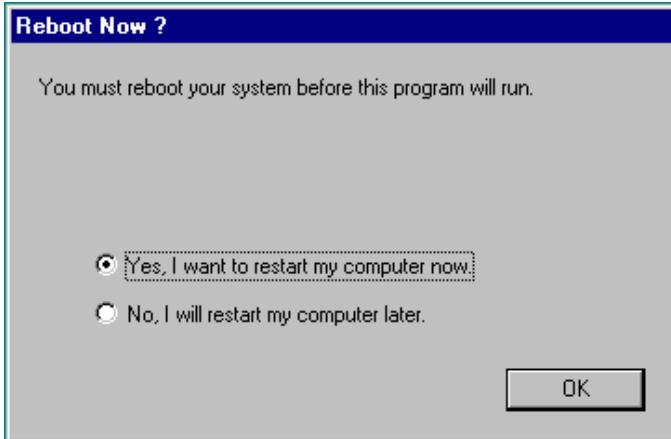

17. Decide whether or not you want to reboot now or later and click .

Important: You must reboot before this program will be able to run.

Run the 1784-KTx Diagnostics for Windows NT

This section contains instructions for you to run 1784-KTX, -KTXD, and KTS diagnostics, which check network and host communications, interrupts, and memory access.

Important: The 1784-KTS card will not run the dual-port test. The test will attempt to run and fail.

When Do I Run Diagnostics?

Run KTx diagnostics if:

- you just installed the KTx card
- you want to test if you have set up the KTx card correctly
- you are unable to communicate with the PLC processor
- remote I/O scanner is unable to communicate with adapters

Troubleshooting the KTx Card

If your KTx card is not functioning properly, follow these steps:

1. If you changed the default settings for the KTx card, check and correct the configuration. You may have configured the KTx card at an address already in use by another module.
2. Continue with the instructions in this appendix to run the diagnostics to determine if there are any hardware failures.
3. If you receive a “No KTx cards are detected” error message see page A-17 for error message explanation.
4. If you have followed the directions for correcting errors on page A-17 and still have an error, call Rockwell Automation Customer Support at 440.646.5800.

Follow these instructions to run the KTx diagnostic tool for Windows NT:

1. Select Start.
2. Select Programs.
3. Select Rockwell Automation.
4. Select KTXDIAG.EXE.

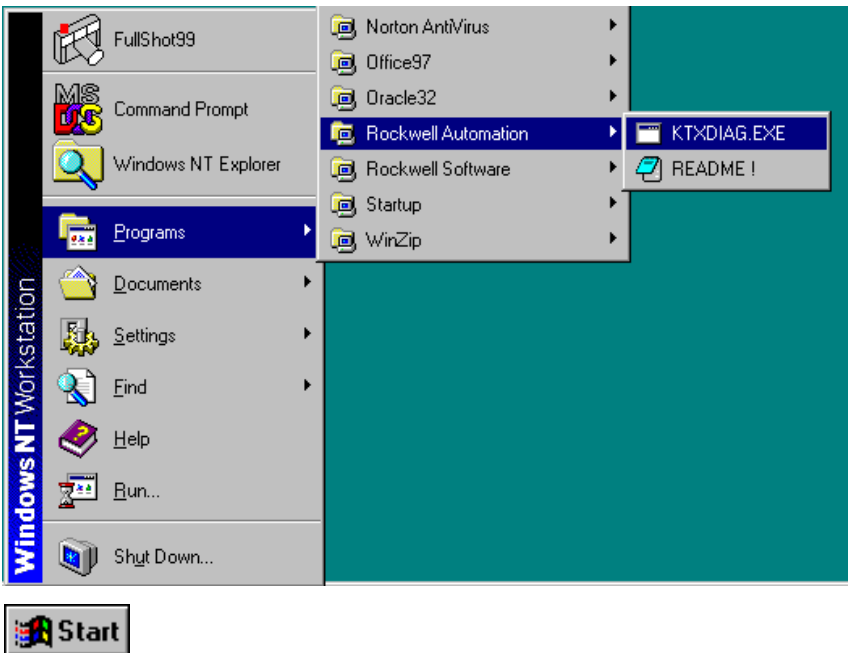

You see:

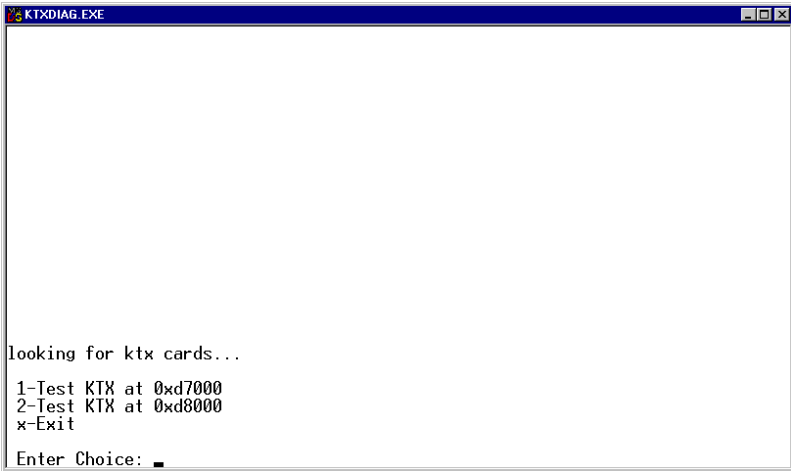

5. Type the number of the card that you need to test.

You see:

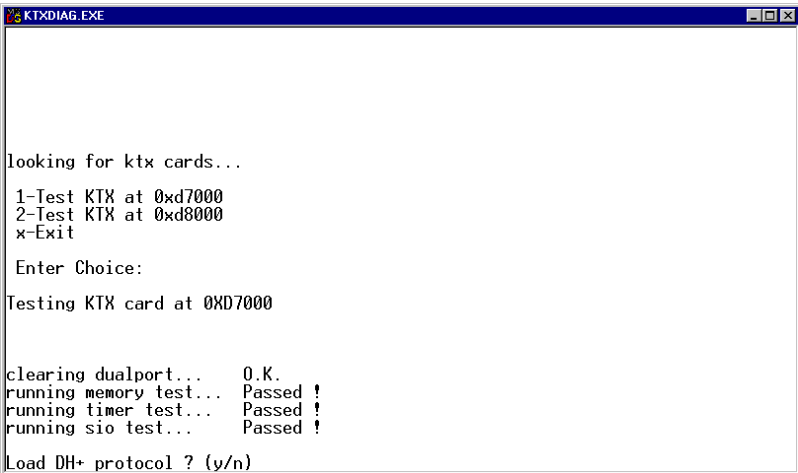

6. Decide whether or not you want to load and view the network protocol (network who).
 - Yes displays the protocol.
 - No displays the previous menu.

When you load the protocol, you see:

```

KTXDIAG EXE
Loading ktxpcl.bin... 0.K.
Enabling DH+ ... 0.K.

1784-KTX DH+ DUAL_PORT INFORMATION

KTX DH+ node address is .....77
KTX DH+ node is .....unique
Link state is .....on-line
Module state is .....enabled
KTX is (KTX side).....functional
Baud rate is .....57.6
KTX is (HOST side).....active
KTX node name is .....1784-KTX
Number of active nodes .....01

Active Node Table:

[00..17] . . . . .
[20..37] . . . . .
[40..57] . . . . .
[60..77] . . . . .77

KTX DH+ Binary Version: 14
(Press any key to continue)
  
```

7. Review the information and if you are connected to a DH+ network and you only see one active node then you will want to check:
 - that the KTx DH+ node is unique (this utility only allows the KTx to be at node 77)
 - that the baud rate is not mismatched (this utility only allows 57.6 kbaud)
 - for bad cable or wiring. Check cable pinouts and press any key to continue.

If

You see:

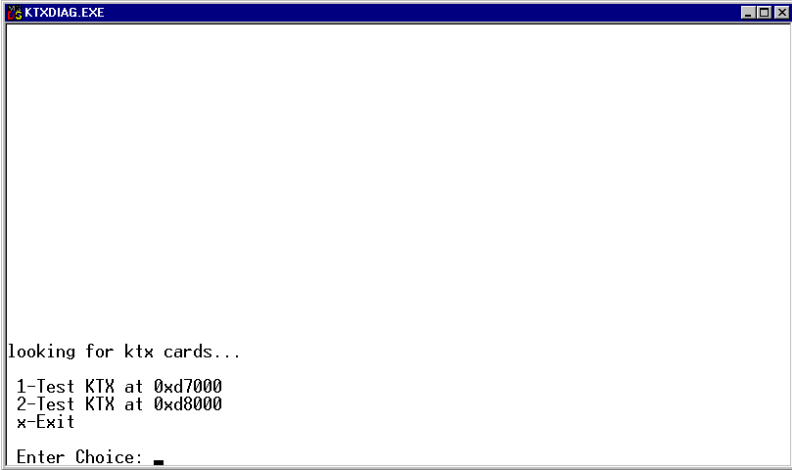

8. Either exit or continue to test other cards installed.

Error Message

The following error message can occur when you run the diagnostics tool.

No KTx cards are detected

If you receive this message, no cards were found installed in your computer.

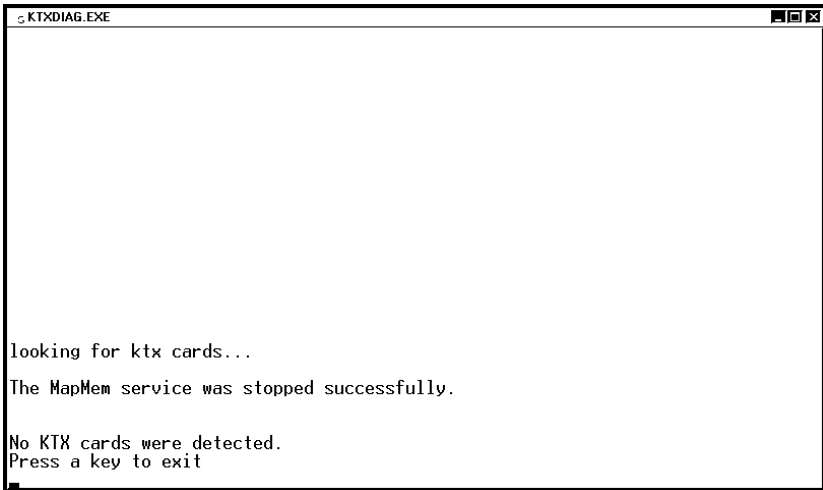

Reasons that the diagnostic tool did not detect your card:

- it did not get the resources you assigned to the card
- unavailable base memory address settings

Follow the instructions in Chapter 2 and try the diagnostics again. If you continue to get this error, call Rockwell Automation Customer Support at 440.646.5800.

- incorrect seating in the card slot

Follow the card installation instructions in Chapter 3 and try the diagnostics again. If you continue to get this error, call Rockwell Automation Customer Support at 440.646.5800.

View the readme.txt file

Please view the readme.txt for additional information.

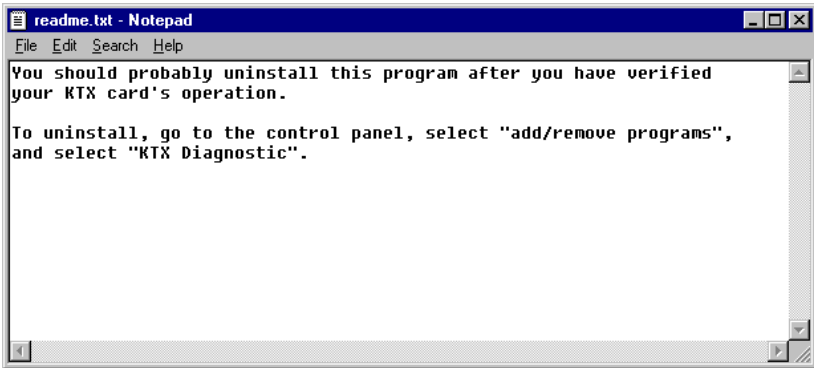

Remove the Card's Diagnostics in Windows NT

We recommend uninstalling the diagnostics program after you have verified your card's operation.

You can access the uninstaller through Windows NT's Add/Remove programs applet to remove the card's drivers from your system.

1. Access the Control Panel by selecting Start/Settings/Control Panel, or go to My Computer and double click on Control Panel.
2. Double-click the Add/Remove Programs icon.



3. Click on KTX Diagnostic to select the program.

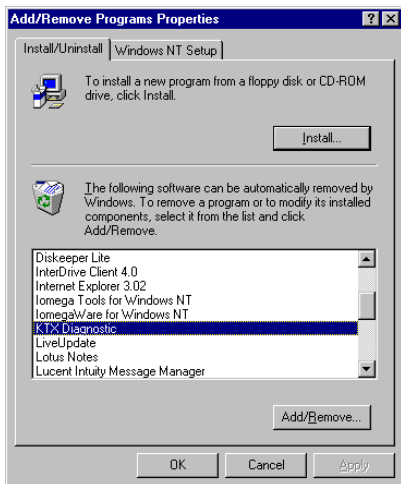

4. Click  .

You see:



5. Click to remove the diagnostics from your computer.
6. Close the Control Panel.

Run the 1784-KTx Diagnostics for DOS

This appendix contains instructions for you to run 1784-KTX, -KTXD, and KTS diagnostics, which check network and host communications, interrupts, and memory access.

Important: The 1784-KTS card will not run the dual-port test, i.e., it will attempt to run and fail.

When Do I Run Diagnostics?

Run KTx diagnostics if:

- you just installed the KTx card
- you want to test if you have set up the KTx card correctly
- you are unable to communicate with the PLC processor
- remote I/O scanner is unable to communicate with adapters

Troubleshooting the KTx Card

If your KTx card is not functioning properly, follow these steps:

1. If you changed the default settings for the KTx card, check and correct the configuration. You may have configured the KTx card at an address already in use by another module.
2. Continue with the instructions in this chapter to run the diagnostics to determine if there are any hardware failures (see pages A-4 through A-20).

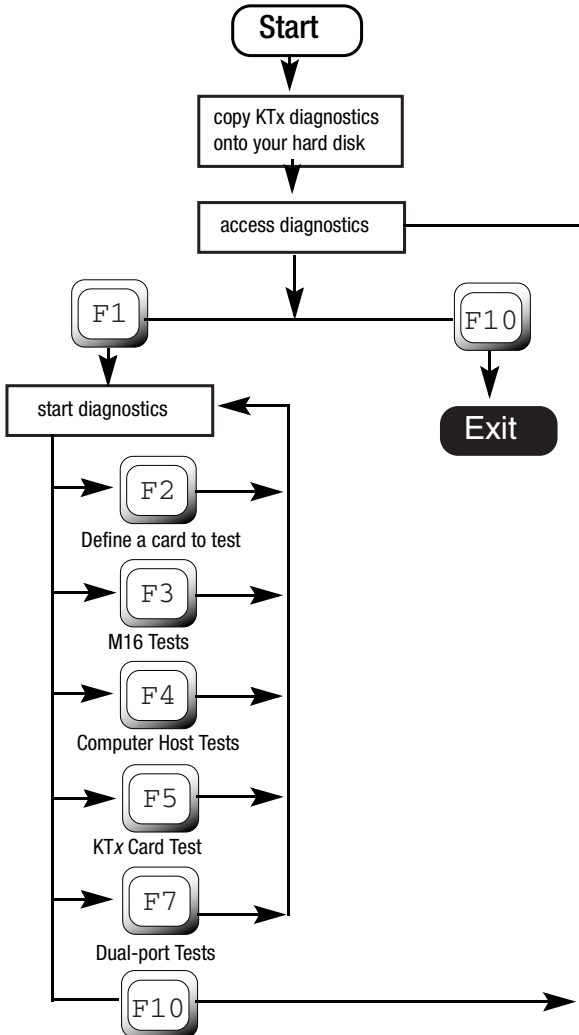

3. If you received any failures, print the log file (see page B-20)
4. Call Rockwell Automation Customer Support at 440.646.5800. Instructions are printed at the beginning of the log file.

Install DOS Diagnostics to Your Hard Drive

Install the diagnostic files with the installation program on the KTx Utility Disk, which came in the box with your KTx card.

1. Insert the utility disk in drive A.
2. Type:
 - a:
3. Type:

`install c`

You see:

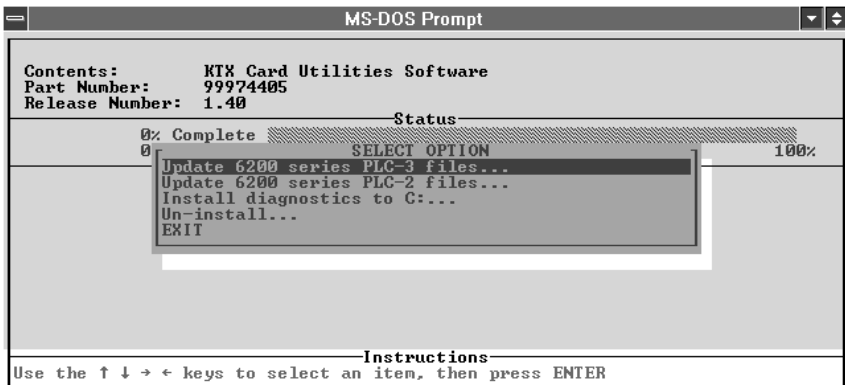

4. Select:

Install diagnostics to C:. . .

You see:

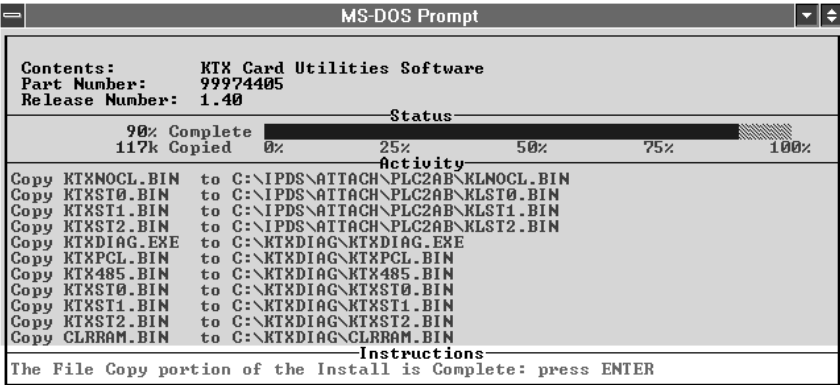

Important: In some instances, the status bar does not reach 100% even though all of the appropriate files have been copied.

5. Press:

Enter

You see the Select Option screen.

6. Select:

Exit

You see the DOS prompt.

Access Diagnostics



ATTENTION: You can run diagnostics on only one card or channel (1784-KTXD) at a time. If you run diagnostics using a memory address that is incorrect, the computer may lock up. Be certain to run diagnostics using the correct address setting (see page 2-4 for the memory address(es) your configured).

At the MS-DOS prompt, type:

```
cd c:\ktxdiag
```

and press Enter.

```
ktxdiag
```

and press Enter.

If you:	Add this to the <code>ktxdiag</code> command:
don't want to create a KTXDIAG.LOG file	-l
are using a monochrome monitor	-m
want to see this list of options	-h -?

You see the introductory screen:

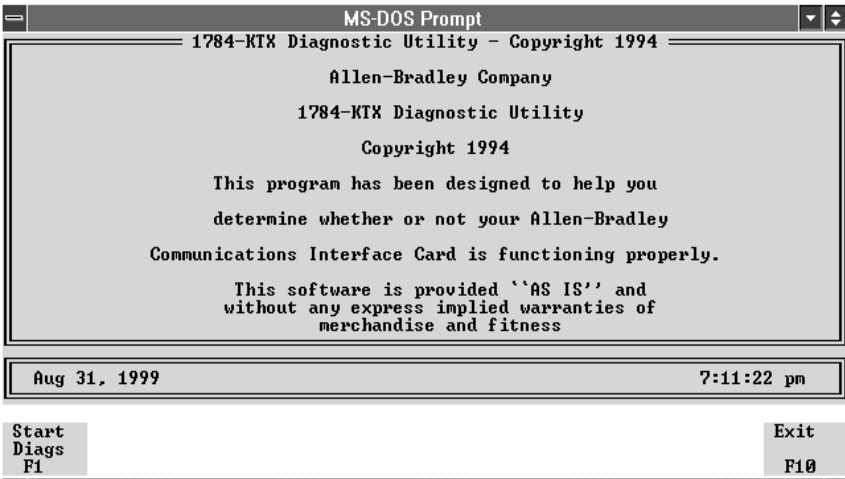

To:	Press this key:	Go to page:
View the diagnostics menu	F1 (Start Diags)	B-6
Exit the software	F10 (Exit)	-

Start Diagnostics

From the introductory screen (see page B-6), press **F1**.

You see the main menu:



The following instructions take you through running the diagnostic tests individually and viewing the error log file.

7. Use the decision table below.

To:	Press this key:	Go to page:
Define a KTx Card to Test	F2 (On-line Configuration)	B-8
Run M16-diagnostics	F3 (M16 Tests)	B-10
Test the computer's ability to communicate with the KTx card	F4 (Computer Host Tests)	B-11
Run the KTx card's self-diagnostics	F5 (KTX Card Tests)	B-13
Test the dual port's ability to communicate	F7 (Dual Port Tests)	B-15
Exit diagnostics	F10 (Return to Previous Menu)	

Define a KTx Card to Test

If you have more than one KTx card installed or you are using a 1784-KTXD card, you need to define which card or which memory address you want to test

Important: If you need to use settings other than the default settings, you must define those settings on this screen.

1. From the main menu (see page B-7), press **F2**.

You see:



2. Change the configuration to match the settings for the KTx card that you want to test.

To change the:	Press this key until you see the setting that you need:
memory address	F4 (Set Memory)
interrupt	F5 (Set Intrrpt)
DH-485 baud	F8 (DH485 Baud)

To change the:	Press this key:	And:
DH+ address	F6 (DH+ Address)	You will be prompted to enter an address DH+ [0 . . . 77] DH-485 [0 . . . 31]
DH-485 address	F7 (DH485 Address)	

3. To save the configuration, press **F9**.

The configuration is saved in the KTXDIAG.INI file in the KTXDIAG directory. The next time that you run diagnostics, the diagnostics program look for this file and loads it. If you don't save your configuration or the diagnostic program can't find the KTXDIAG.INI file, it substitutes the default address and interrupt settings for the KTx card (see page B-5 and page B-8).

4. To return to the introductory screen (see page B-6), press **F10**.

Run M16 Tests

1. From the main menu (see page B-7), press **F3**.

You see:

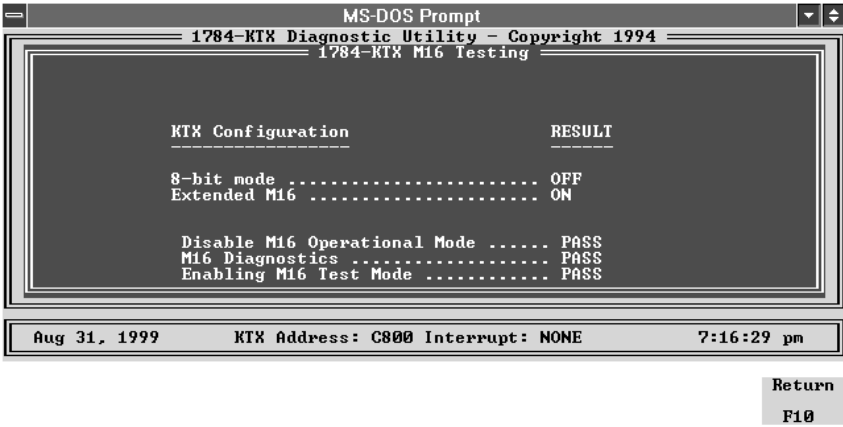

Important: If you are in 8-bit mode, you'll see only the first two lines; those lines will indicate 8-bit mode ON and Extended M16 OFF. You cannot run M16 tests in 8-bit mode.

Test Your Computer

1. From the main menu (see page B-7), press **F4**.

You see:



2. Use the decision table below.

To:	Press this key:
execute the tests	F1 (Execute Tests)
return to the main menu (page B-7) without running the test	F10 (Return)

If you pressed **F1**, you see:



If an error occurs, the diagnostics report a failure and continues with the next test. Errors are recorded in the log file (page B-20).

Diagnostic:	Description:	If this test fails:
Dual Port	Tests the computer's ability to read to and write from dual-port memory.	<ul style="list-style-type: none"> RAM memory may be corrupted KTx card may have a problem (run the KTx card test)
Reset Test	Tests the computer's ability to reset the KTx card After reset, verifies the status of the KTx card	<ul style="list-style-type: none"> KTx card may have a problem (run the KTx card test)
Interrupt	Tests the interrupt capability from the KTx card to the computer	<ul style="list-style-type: none"> There may be a conflict in the interrupt assignments

3. Press **F10** to return to the main menu (page B-7).

Test the KTx Card

1. From the main menu (page B-7), press **F5**.

You see:



2. To execute the tests, press **F1**.

To return to the main menu (page B-7) without running the test, press **F10**.

If you pressed **F1**, you see:

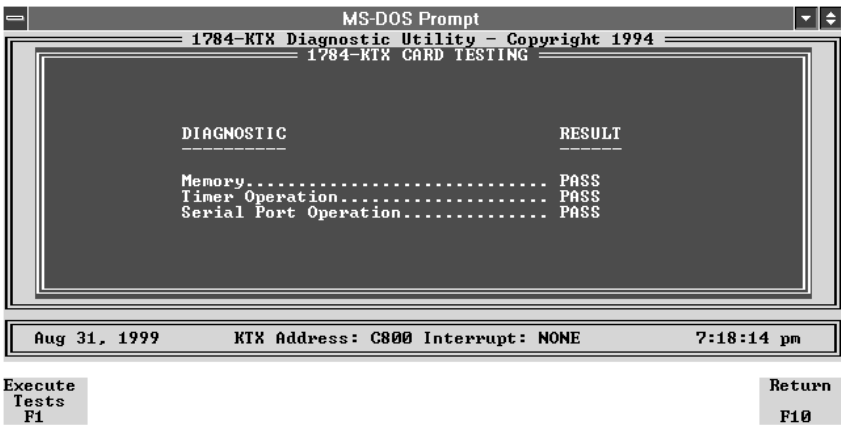

If an error occurs, the diagnostics report a failure and continues with the next test. Errors are recorded in a log file (see page A-20).

Diagnostic	Description	If the test fails:
Memory	Tests the KTx card's ability to read from and write to its internal memory chips	The KTx card's RAM may have a problem
Timer Operation	Tests the accuracy and capabilities of the counter-timer chips	KTx card may not have reset completely <ol style="list-style-type: none">1. Turn power off to the computer.2. Remove the card and reinsert.3. Turn power on to the computer.4. Run this test again.
Serial Port Operation	Tests the interrupts and loopback capabilities of the serial I/O chip	<ul style="list-style-type: none">• There may be a hardware problem with the KTx card.• The wrong set of KTx*.BIN files are running.

Test the Dual Port

- From the main menu (page B-7), press **F7**.

You see:

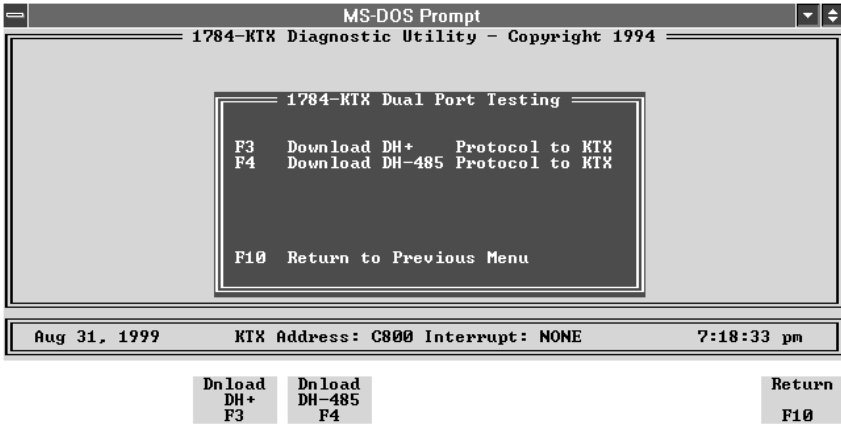

- Use the decision table below.

To load this protocol to the KTx card:	Press this key:
DH+ (page B-17)	F3 Download DH+
DH 485 (page B-17)	F4 Download DH 485
return to the main menu (page B-7)	F10 Return

If you press:	You see the message:
F3 Download DH+	DH+ Loading TestLOADED
F4 Download DH 485	DH-485 Loading Test LOADED

Then you see:

For DH+

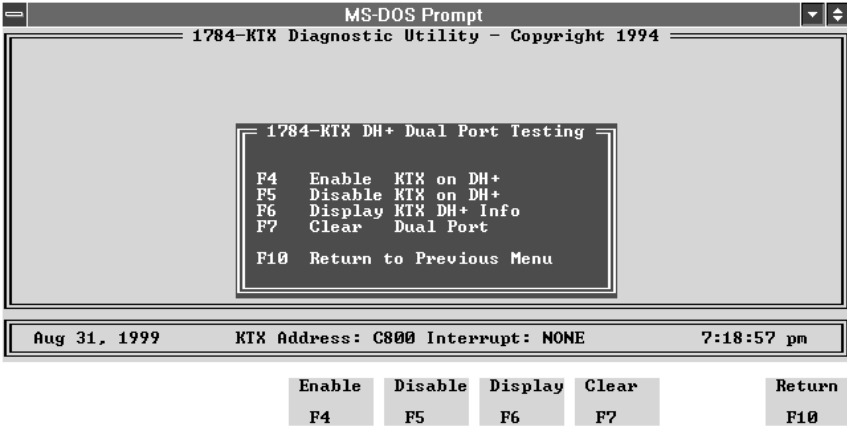

For DH-485

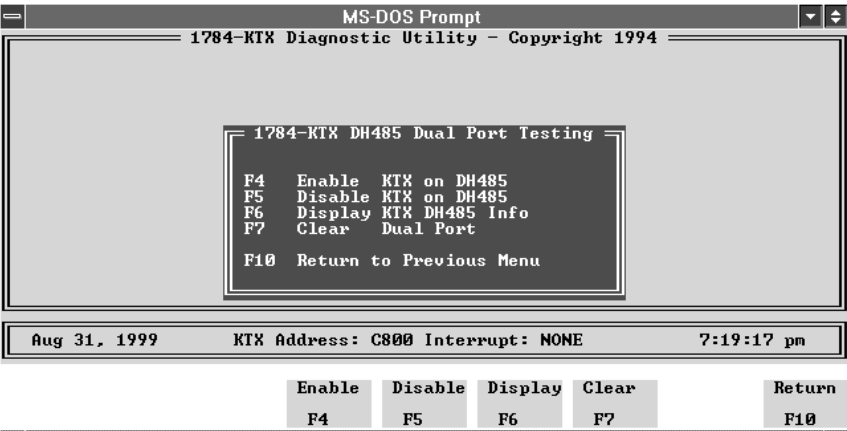

3. Use the decision table below for both protocols.

To:	Press this key:
enable the KTx card on a DH+ or DH-485 link (page B-17)	F4 Enable
disable the KTx card from a DH+ or DH-485 link (disables the card from the network but protocol is not removed from the card)	F5 Disable
display the KTx card on DH+ or DH-485 link	F6 Display
clear the memory location of the KTx card <ul style="list-style-type: none"> disables card from the DH+ or DH-485 link clears the DH+ or DH-485 protocol from the card 	F7 Clear
return to the main menu (page B-7)	F10 Return

4. Press **F4** to enable the card.

If everything is operating successfully, you see the message:

- DH+ Enabling Test ENABLED for DH+
- DH485 Enabling Test ENABLED for DH-485

5. Press **F6** to view the card's information.

For DH+

```

MS-DOS Prompt
1784-KTx Diagnostic Utility - Copyright 1994
KTx DH+ node address is .....
KTx DH+ node is .....
Link state is .....
Module state is .....
KTx is (KTx side).....
Protocol software is .....
Baud rate is .....
KTx is (HOST side).....
KTx node name is .....
Number of active nodes .....
[00..17] . . . . .
[20..37] . . . . .
[40..57] . . . . .
[60..77] . . . . .

Aug 31, 1999      KTx Address: C800 Interrupt: NONE      7:20:19 pm
Return
F10

```

For DH-485

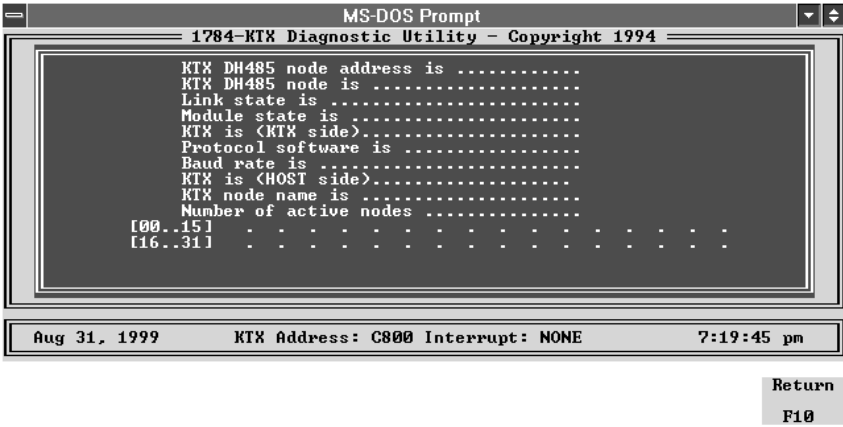

Important: The address of the KTx card for this test is fixed at 77 octal. If other nodes use this address, you will see duplicate nodes on the network.

This field:	Indicates:
KTx node address is	the node address of the KTx card
KTx DH+ or DH-485 node is	if the node is unique or a duplicate
Link State is	if the DH+ or DH-485 link is on line or off line or unknown
card state is	if the KTx card is enabled or disabled
KTx is (KTx side)	if the communication from the card to the computer is functional or not functional
Protocol Software is	if the protocol software is: <ul style="list-style-type: none"> • DH+ or unknown • DH-485 or unknown
Baud rate is	the communication rate is: <ul style="list-style-type: none"> • for DH+: 57.6 bps or unknown • for DH-485: 300, 600, 1200, 2400, 4800, 9600, 19200, or unknown
KTx is (host side)	the communication from the computer to the card is active or stopped
KTx node name is	the name you assigned to the computer in your application or the default name 1784KTx
Number of active nodes	the number of active nodes and shows a map of the nodes on the DH+ or DH-485 link if the card is communicating on the DH+ or DH-485 link
(untitled)	active nodes on network displayed as 'mini-who'

This test reports the current status of DH+ or DH-485 communications. The test results are recorded in the log file. Use this information to help you troubleshoot. If you encounter any difficulty, review your error log.

Print the Log File

If you did not add **-1** to the **ktxdia** command (see page B-5) when accessing diagnostics, your diagnostic test session was recorded in a log file that helps Allen-Bradley Automation Group Technical Support diagnose your difficulty.

1. To view the log file, at the MS-DOS prompt, type:

cd c:\ktxdia and press ENTER. If you are running the KTx utilities from another drive, use the appropriate drive letter instead of **c**:

type ktxdia.log | more and press ENTER.

2. Use MS-DOS commands or a text editor to print a copy of the log file.

```

1784-KTX Diagnostic v1.0
Feb 23, 1994 2:39:38 pm
*****
Allen-Bradley Global Technical Services
6680 Beta Drive
Mayfield Village, OH 44143
Voice Phone: 440.646.6800
FAX Phone: 440.646.6890
BB Phone: 440.646-6728
*****
COPYRIGHT NOTICE
-----
Allen-Bradley 1784-KTX Diagnostic Program
Copyright 1994 Allen-Bradley Company
This program has been designed to help you
determine whether or not your Allen-Bradley
1784-KTX Card is functioning properly.
This software is provided 'AS IS' and
without any express implied warranties of
merchantability and fitness
for a particular purpose.
*****
Reading KTXDIAG.INI
-----
(KTX Card)
DPA=300
INTR=0xPPFF
*****
Configure KTX Card
-----
*****
MAIN MENU
-----
*****
1784-KTX CARD TESTING Started
-----
*****
Memory.....PASS
Timer Operation.....PASS
Serial Port Operation.....PASS
*****
1784-KTX CARD TESTING Completed
*****
....COMPLETED
1784-KTX Diagnostic v1.0

```

3. Call Rockwell Automation Technical Support at: 440.646.5800 and request a customer log number and the name of a technical support specialist. Include this information on the fax cover letter along with the log print-out. Fax everything to the number indicated on the print-out.

Use the KTx Card with 6200 Software

You can use the KTx card with Allen-Bradley PLC-2™, PLC-3™, PLC-5™, and PLC-5/250 programmable controllers using 6200 software.

KTx Card and 6200 Software for PLC-5 and PLC-5/250 Programmable Controllers

Current versions of Allen-Bradley 6200 software for PLC-5 and PLC-5/250 programmable controllers have built-in support for the KTx card. If your version does not support the KTx card, you must upgrade to the latest version of 6200 software before attempting to connect.

KTX Card and 6200 Software for PLC-2 Direct-connect and PLC-3 Direct-connect

Important: You can use only the 1784-KTX card for PLC-2 and PLC-3 direct-connect. The 1784-KTS and 1784-KTXD **do not** support direct connection to a PLC-2 or PLC-3 processor.

To use the KTX card for direct-connect operation to a PLC-2 or PLC-3 programmable controller, follow these steps:

Important: The screen prints presented here may not contain the same part and release number as your KTx Utility software.

1. Set the memory address on the card to one of the following:

• CB00:	• D300:	• DB00:
• CF00:	• D700:	• DF00:

See Chapter 2 for additional information.

2. Install the card in the computer by following the instructions in Chapter 3.

Important: The following procedure to run the installation program is not necessary with later versions of software. If your software lists the KTx as an option, the utility is already installed.

3. Run the installation program on the KTx Utility Disk, which came in the box with your KTx card.

A. Insert the utility disk in drive A.

B. Type: a:

C. Type: install c

4. Select the 'update' routine specific to your processor.

- Update 6200 series for PLC 3 files . . .
- Update 6200 series for PLC 2 files . . .

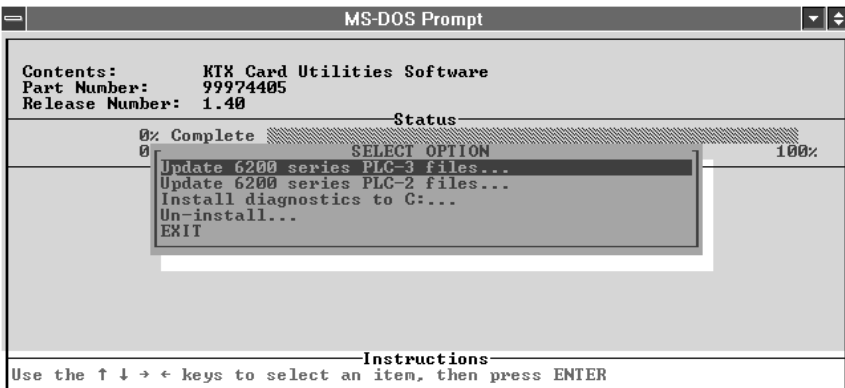

5. Select the 'update' routine for the KTx files.

For a PLC-3 processor, select:

Update target drive PLC 3 files with 1784 KTX files

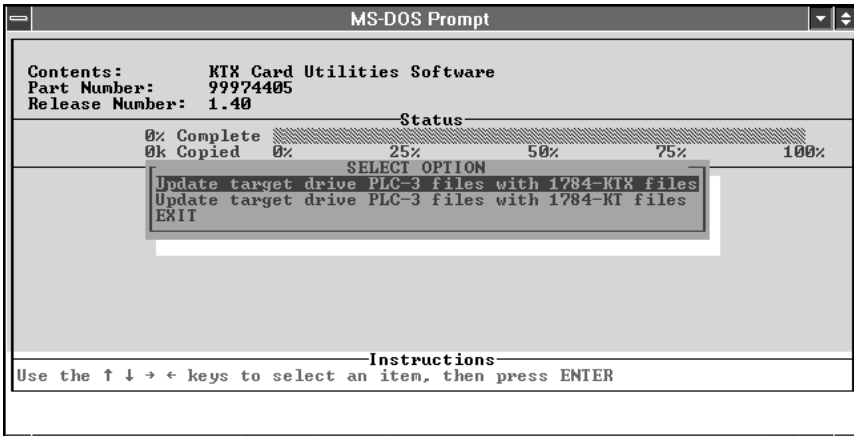

You see:

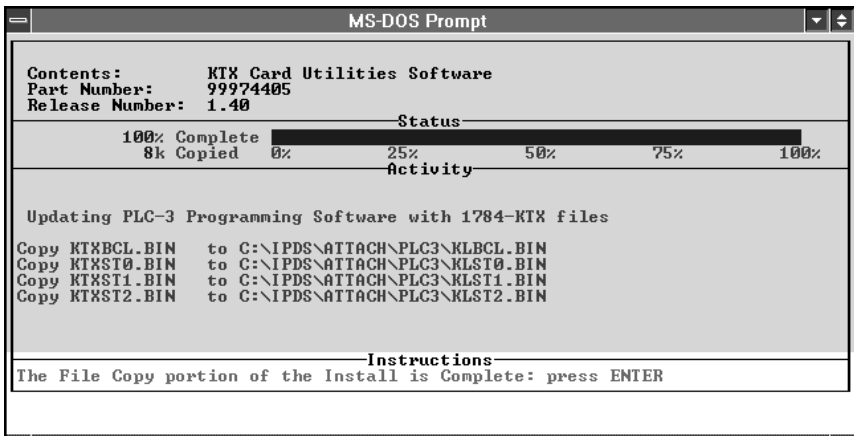

Important: In some instances, the status bar does not reach 100% even though all of the appropriate files have been copied.

For a PLC-2 processor, select:

Update target drive PLC 2 files with 1784 KTX files

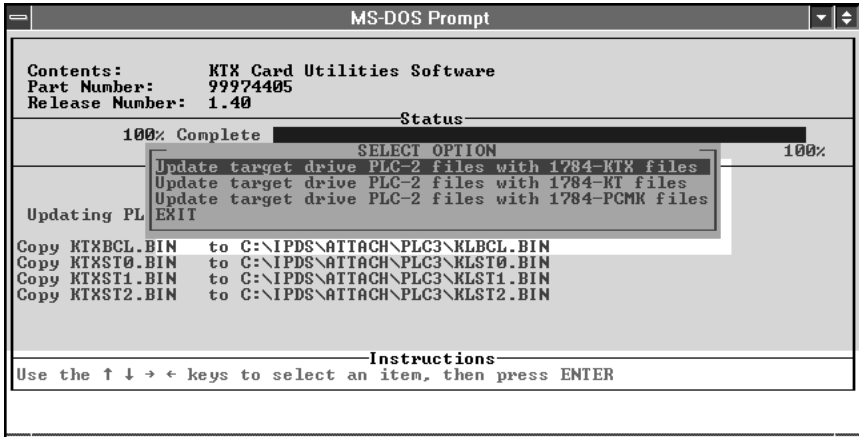

You see:

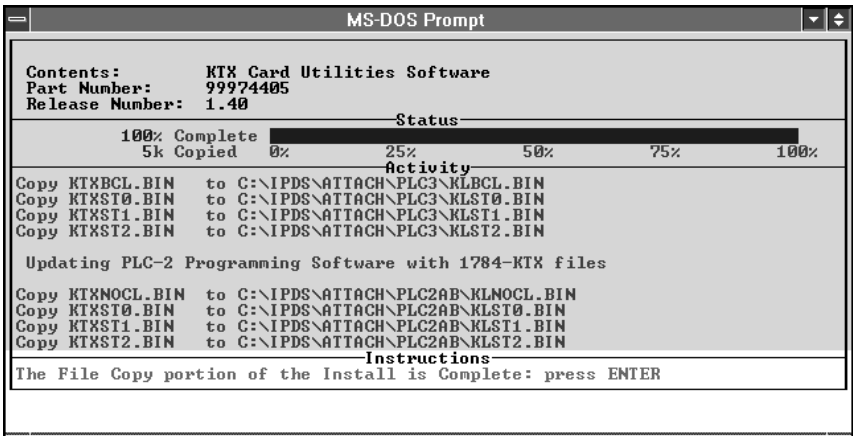

6. Exit the installation program.

7. Connect the appropriate cable from the card to the port on the programmable controller:
 - 1784-CP15 for PLC-2
 - 1784-CP16 for PLC-3
8. Start 6200 software for the PLC-2 or PLC-3 programmable controller running on the computer.
9. Go to on-line configuration and set the current device to:
 - “1784-KT (Direct Con.)” for PLC-2 programmable controllers
 - “1784-KT (BCL)” for PLC-3 programmable controllers
10. Set the address on the on-line configuration screen to the following bit patterns, corresponding to the selections on the KTx card:

• 010011 (CB00:)	• 001011 (D300:)	• 011011 (DB00:)
• 110011 (DF00:)	• 101011 (D700:)	• 111011 (DF00:)

6200 PLC-2 and PLC-3 software supports only these addresses.

11. Save the configuration.
12. Go on line to confirm that everything is set correctly.

During subsequent programming sessions, these steps do not need to be repeated.

Numerics

- 1771 remote I/O networks 4-1
- 1784-KTS connections 4-2
- 1784-KTx card
 - configuring 2-1
- 1784-KTx cards
 - features supported by 1-1
 - installation 3-1
 - selecting interrupt settings 2-7
 - setting card switches 2-6
- 1784-KTX connections 4-1
- 1784-KTXD connections 4-2
- 6200 software C-1

A

- address selection worksheet 2-5

B

- base memory address
 - recommended memory address settings 2-3
- base memory location 2-1

C

- connecting to an SLC 500 processor 4-9
- connecting via a DH-485 network 4-8

D

- DH+ 4-3
 - connecting devices to the 1784-KTX card 4-4
- DH+ networks 4-1
- DH-485 4-3
- DH-485 networks 4-1
- diagnostics A-12, B-1
 - accessing B-5
 - defining card to test B-8
 - installation B-3
 - M16 test B-10
 - testing the card B-13
 - testing the dual port B-15
 - testing your computer B-11

E

expansion slots 3-3

H

host computer IRQ assignments 2-9

I

installing the card's driver
on Windows NT A-1

J

jumper settings worksheet 2-10

K

KTx interrupts 2-7

L

log file B-20

M

M16 test B-10

P

PLC classic programmable controllers 4-3
PLC enhanced programmable controllers 4-3
PLC-2 direct connect 4-3
PLC-3 direct connect 4-3

R

remote I/O 4-3
removing the card's driver
in Windows NT A-19

S

selecting the interrupt settings 2-7
setting the card's switches 2-6
SLC processors 4-3

T

troubleshooting A-12, B-2



Allen-Bradley Publication Problem Report

If you find a problem with our documentation, please complete and return this form.

Pub.
Name _____

Cat. _____ Pub. _____ Pub. _____ Part _____
No. _____ No. _____ Date _____ No. _____

Check Problem(s) Type:	Describe Problem(s)
<input type="radio"/> Technical Accuracy	<input type="radio"/> text <input type="radio"/> illustration <input type="radio"/>
<input type="radio"/> Completeness What information is missing?	<input type="radio"/> procedure/ <input type="radio"/> illustration <input type="radio"/> definition <input type="radio"/> example <input type="radio"/> guideline <input type="radio"/> feature <input type="radio"/> explanation <input type="radio"/> other
<input type="radio"/> Clarity What is unclear?	
<input type="radio"/> Sequence What is not in the right	
<input type="radio"/> Other Comments Use back for more	

Your Name _____ Location/ Phone _____

Return to: Technical Communications, Allen-Bradley, 1 Allen-Bradley Drive, Mayfield Hts., OH 44124-6118 Phone: 440.646.3176 FAX: 440.646.4320



NO POSTAGE
NECESSARY
IF MAILED
IN THE

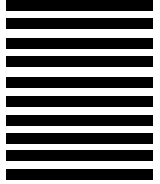

BUSINESS REPLY MAIL
FIRST-CLASS MAIL PERMIT NO. 18235 CLEVELAND OH

POSTAGE WILL BE PAID BY THE ADDRESSEE

Technical Communication
1 ALLEN BRADLEY DR
MAYFIELD HEIGHTS OH 44124-9705



www.rockwellautomation.com

Power, Control and Information Solutions Headquarters

Americas: Rockwell Automation, 1201 South Second Street, Milwaukee, WI 53204-2496 USA, Tel: (1) 414.382.2000, Fax: (1) 414.382.4444

Europe/Middle East/Africa: Rockwell Automation, Vorstlaan/Boulevard du Souverain 36, 1170 Brussels, Belgium, Tel: (32) 2 663 0600, Fax: (32) 2 663 0640

Asia Pacific: Rockwell Automation, Level 14, Core F, Cyberport 3, 100 Cyberport Road, Hong Kong, Tel: (852) 2887 4788, Fax: (852) 2508 1846

Publication 1784-6.5.22 - November 1999

PN 955135-70

Supersedes Publication 1784-6.5.22-RN1 July 1997

Supersedes Publication 1784-6.5.22 - December 1994

© (1999) Rockwell International Corporation. Printed in the U.S.A.